



Rails, Rails, Rails
Find the right rail system and accessories for all mission requirements

Variable Eye Relief
Adjustable mounts and rings for preferred scope placement

Fiber-optic Sights
Precision pistol & rifle sights for quick & accurate targeting

TACTICAL ACCURACY CONFIDENCE

Supporting You with Hundreds of Mounting Solutions and Firearm Accessories for the LE Professional, Sport and Competitive Community

GRIP POD SYSTEMS

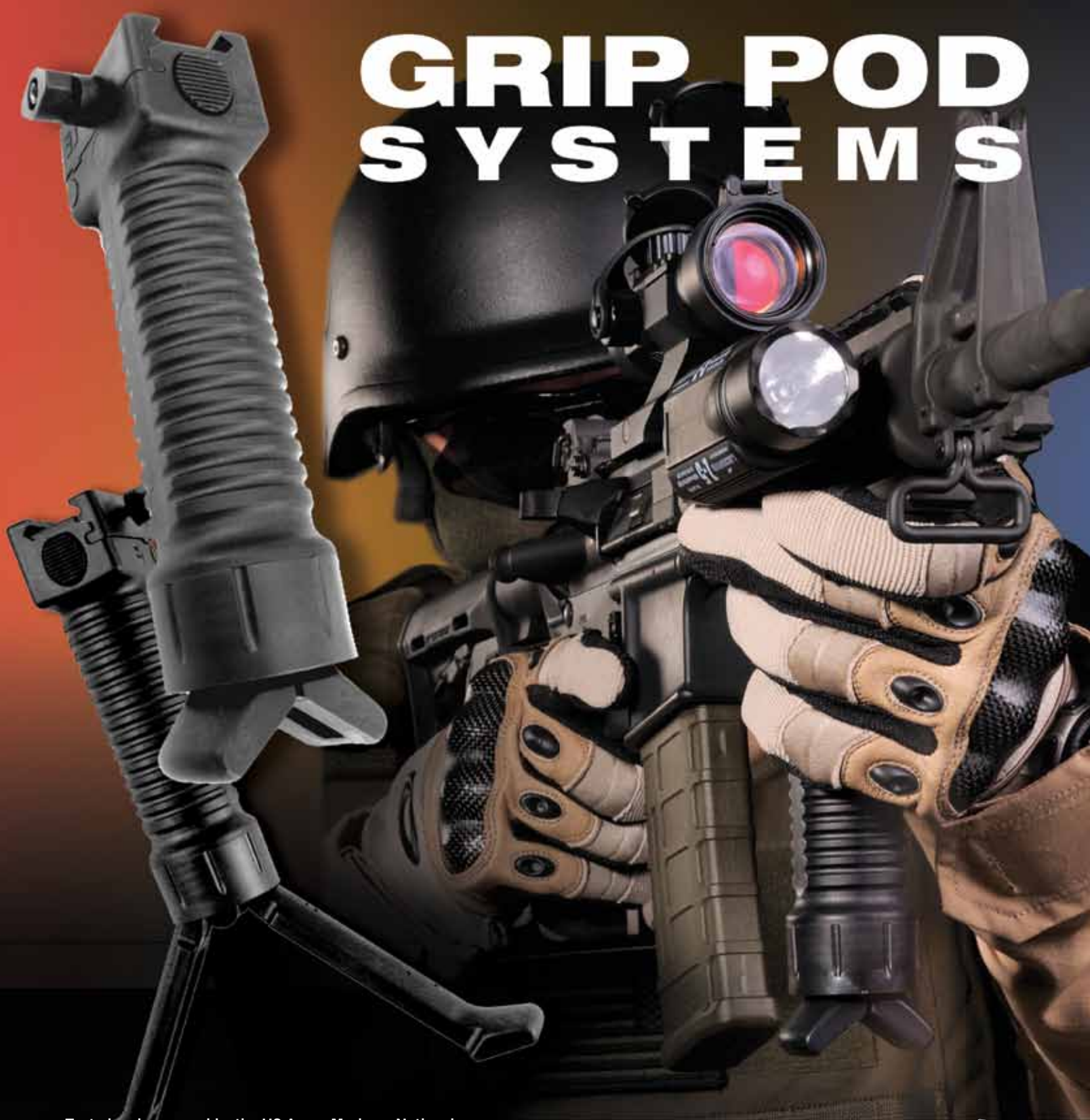

Tested and approved by the US Army, Marines, National Guard and the British Armed Forces as their premiere weapon stabilizing system.

The Grip Pod System™ (GPA™) is a revolutionary vertical fore-grip integrated with a strong and stable bipod. The Grip Pod's legs deploy at the push of a button - instantly! It offers a combination of advantages never before available in a single accessory. The GPA™ is manufactured from aerospace materials to exceed military specifications for construction and finish. It mounts directly to all Picatinny rail systems, and additional mounting options will be available soon.

GPA-000-GP1	Black, Tactical with Steel reinforced legs
GPA-000-GP3	Tan, Tactical with Steel reinforced legs
GPA-000-LE	Black, LE Version
GPA-000-LET	Tan, LE Version

Grip Pod Light Rail Module

The Light Rail Module adds a rail system to the Grip Pod System and allows the user to have a tactical light or laser at their finger tips. Simply attach the LRM to the Grip Pod System and then add any tactical accessory to the LRM rail and continue with the mission.

#GPA-000-LR1	Black, Single Light Rail
#GPA-000-LR2	Black, Double Light Rail
#GPA-000-LR1T	Tan, Single Light Rail
#GPA-000-LR2T	Tan, Double Light Rail

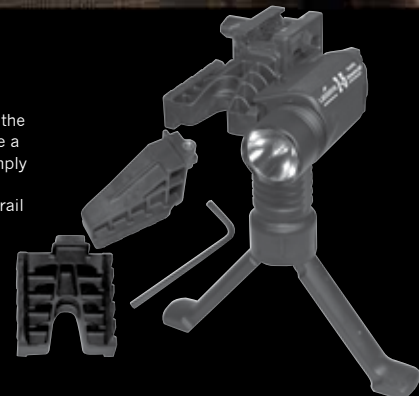

New for 2011

MSP Variable Eye Relief Scope Mount and 30mm Rings with MOA
See Page 8



Hammerhead AR-15 Rifle Tool
See Page 21



Vortex SPARC Red Dot Scope
See Page 55



A.R.M.S. #71L series Sights
See Page 19



Samson K-Rail Model for the AK
See Page 27



RIANOV Range Finding/Ballistic Calculator Measures targets to determine range and calculates Ballistic Solution
See Page 61



ATI AK Strikeforce Collapsible, Side Folding Stock
See Page 27

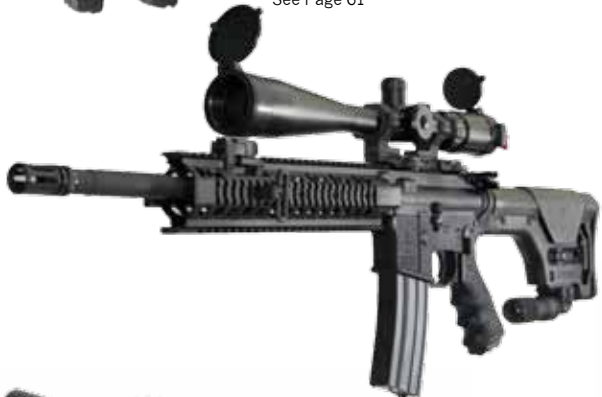

Adams Arms Drop-In Piston Conversion Kits
See Page 20

Nightforce Optics
See page 46



PRI Gen III Delta Carb Fiber Forearm
Designed for most piston or op-rod systems
See page 18



ITT Shot Shock - Shotgun Recoil Buffer
See Page 45



ERGO Three Rail Shotgun Forend
see Page 45



Featured Sections

6 Scope Rings & Mounts

Weaver, A.R.M.S., PRI

9 AR Rail & Accessories

A.R.M.S., Samson & Magpul

22 Ruger 10/22 Accessories

Muzzelite, ATI, Shooters Ridge

24 Mini 14 Accessories

Tapco, ATI

26 AK Accessories

Tapco, Samson & ATI

28 H&K Accessories

A.R.M.S., Samson, MFI

29 M14/M1A Accessories

A.R.M.S. & Sadlak Ind.

29 FAL Accessories

Magpul, A.R.M.S., & Tapco

30 Remington 700

PRI & Weaver

34 Grips, Bipods & Slings

Magpul, AccuShot & Harris Bipods

40 Handgun Accessories

Ghost, Weigand & Ameriglo

44 Shotgun Accessories

ATI, Ergo, L&M & CDM Gear

48 Scopes & Optics

Aimpoint, BSA, Eotech, Nightforce, Trijicon, Vortex & Weaver

65 Flashlights & Light Sticks

Ameriglo, Surefire, Streamlight

L&M Shotgun Magazine Tubes Mount

See Page 46



CDM Gear BMT - Barrel Magazine Tube Mount
See Page 46

Magnum Weaver Style Scope Rings

For use with MAGNUM calibers.

Two rings for .22 LR to .44 Magnum (Medium Loads)
 Three ring set for .44 Magnum (Heavy Loads) to .500 (Light Loads)
 Four Rings for full power .460 and .500 Magnum

2 Scope Ring Set

- #WCM-RNG-01S 1" Silver
- #WCM-RNG-01B 1" Black
- #WCM-RNG-30S 30mm Silver
- #WCM-RNG-30B 30mm Black

3 Scope Ring Set

- #WCM-3RS-01S 1" Silver
- #WCM-3RS-01B 1" Black
- #WCM-3RS-30S 1" Silver
- #WCM-3RS-30B 1" Black



Weaver Style 34mm Scope Ring

2 Scope Ring Pair
 #WCO-RNG-C34 Black



NcStar 30mm/1" Scope Rings

- 30mm Weaver rings with 1" inserts
- Aluminum Construction
- #111-NCS-RB04 Height: 1.3", Black
- #111-NCS-RB06 Height: 1.5", Black



NcStar 1" Scope Rings

- 1" Weaver rings
- Aluminum Construction
- Height: 1.4"
- #111-NCS-RB13 Black



NcStar 1" Quick Release Scope Rings

- 1" Weaver rings with quick release
- Steel Construction
- #111-NCS-RB31 Height: 0.9", Black
- #111-NCS-RB33 Height: 1.0", Black



NcStar 30mm/1" Ruger 77 Rings

- 30mm Ruger rings with 1" inserts
- Aluminum Construction
- SOLD INDIVIDUALLY
- #111-NCS-RUB26 Height: 1.0", Black
- #111-NCS-RUB28 Height: 1.1", Black
- #111-NCS-RUS26 Height: 1.0", Silver
- #111-NCS-RUS28 Height: 1.1", Silver



Redfield Scope Rings

- Redfield Aluminum Rings are lightweight, tough and economical. Fits Weaver top Mounts Bases.
- #105-RFD-47311 1" Medium, Gloss Black
 - #105-RFD-47312 1" Medium, Matte Black
 - #105-RFD-47315 1" High, Gloss Black
 - #105-RFD-47325 1" See-Thru, Matte Black
 - #105-SIM-47323 30mm Medium, Matte Black
 - #105-SIM-47324 30mm Medium, Gloss Black



Redfield Steel Dovetail Rings

- These rings feature the positive dovetail locking system and boast rear mount windage adjustments. They offer maximum strength in steel construction and top-notch recoil resistance for the ultimate hold on your scope.
- #105-RFD-47214 1" High Nickel
 - #105-RFD-47218 1" STR XTF Medium Gloss Black
 - #105-RFD-47221 1" XTR XTF Medium Gloss Black
 - #105-RFD-47220 1" STR XTF High Gloss Black
 - #105-RFD-47379 1" STR XTF High Matte Black
 - #105-RFD-47215 1" STR XTF High Nickel
 - #105-RFD-47250 30mm Medium Matte Black
 - #105-RFD-47383 30mm Medium Gloss Black
 - #105-RFD-47251 30mm High Gloss Black
 - #105-RFD-47256 30mm High Matte Black
 - #105-RFD-47254 30mm STR XTF High Matte Black
 - #105-RFD-47255 30mm STR XTF High Gloss Black



Redfield Steel Dovetail Bases

- Dovetail Rings offered as a one or two-piece system. These all-steel bases provide recoil resistance and feature the dovetail locking system for an ultra-secure positive lock-on rings.
- #105-RFD-47183 2pc Browning A-Bolt LA/SA Gloss Black
 - #105-RFD-47152 1pc Remington 700 LA Gloss Black
 - #105-RFD-47169 1pc Remington 700 SA Gloss Black
 - #105-RFD-47273 1pc Remington 700 SA Matte Black
 - #105-RFD-47171 1pc Remington 4, 6, 74, 7400, 7600 Gloss Black
 - #105-RFD-47274 1pc Remington 4, 6, 74, 7400, 7600 Matte Black
 - #105-RFD-47193 2pc Remington 700 LA/SA Gloss Black
 - #105-RFD-47270 2pc Remington 700 LA/SA Matte Black
 - #105-RFD-47191 2pc Savage 10, 110 LA/SA Gloss Black
 - #105-RFD-47269 2pc Savage 10, 110 LA/SA Matte Black
 - #105-RFD-47150 1pc Savage 110 LA Gloss Black
 - #105-RFD-47353 2pc Winchester 70 Matte Black



Redfield Detachable Steel Rings

- These quick detach steel rings are the Original Weaver style Scope Rings.
- #105-RFD-47330 1" Medium Matte Black
 - #105-RFD-47331 1" Medium Silver
 - #105-RFD-47332 1" High Matte Black
 - #105-RFD-47333 1" High Silver
 - #105-RFD-47334 1" Ex-High Matte Black
 - #105-RFD-47335 1" Ex-High Matte Silver



Redfield Steel .22 Rings

- Redfield Scope Rings are constructed of solid steel which yields amazing strength and scope retention.
- #105-RFD-47428 1" Medium Nickel
 - #105-RFD-47430 1" Medium Matte Black
 - #105-RFD-47432 1" Medium Gloss Black
 - #105-RFD-47285 1" High Gloss Black
 - #105-RFD-47287 1" High Matte Black
 - #105-RFD-47431 1" Ex High Matte Black
 - #105-RFD-47433 1" Ex High Gloss Black



Redfield Steel .22 & Airguns Rings

- Redfield Scope Rings are constructed of Aluminum.
- #105-RFD-47320 1" Medium Matte Black
 - #105-RFD-47321 1" Medium Silver
 - #105-RFD-47322 1" Medium Gloss Black



Simmons Scope Rings

- Simmons Aluminum Rings are lightweight, tough and economical. Fits Weaver top mounts bases.
- #105-SIM-49166 1" Medium, Silver
 - #105-SIM-49167 1" Medium, Gloss Black
 - #105-SIM-49168 1" Medium, Matte Black
 - #105-SIM-49171 1" High, Gloss Black
 - #105-SIM-49172 1" High, Matte Black
 - #105-SIM-49173 1" High, Silver
 - #105-SIM-49174 30mm Medium, Matte Black
 - #105-SIM-49175 30mm High, Matte Black



Simmons .22 Scope Rings

- Simmons Aluminum Rings are lightweight, tough and economical. Fits 3/8" Grooved Receivers.
- #105-SIM-49169 1" Medium, Matte Black
 - #105-SIM-49170 1" Medium, Silver
 - #105-SIM-49178 1" Medium, Gloss Black



Weaver Grand Slam Steel Dovetail Rings

These rings feature the positive dovetail locking system and boast rear mount windage adjustments. They offer maximum strength in steel construction and top-notch recoil resistance for the ultimate hold on your scope.



- #105-WVR-49200 1" Low Black
- #105-WVR-49201 1" Low Matte
- #105-WVR-49202 1" Med Black
- #105-WVR-49203 1" Med Matte
- #105-WVR-49239 1" Med Nickel
- #105-WVR-49204 1" High Black
- #105-WVR-49205 1" High Matte
- #105-WVR-49238 1" High Nickel
- #105-WVR-49206 1" X-High Black
- #105-WVR-49207 1" X-High Matte
- #105-WVR-49226 30MM X-High Black
- #105-WVR-49227 30MM Med Matte
- #105-WVR-49208 30MM High Black
- #105-WVR-49209 30MM High Matte

Weaver Grand Slam Steel Cross Lock Rings

Solid steel construction means that Weaver Grand Slam™ Rings perform time after time when the pressure is on. The time tested Weaver cross lock design means a tight, secure fit on your favorite rifle. Now available in silver, there is a Grand Slam ring designed to fit all of your shooting needs.



- #105-WVR-49302 1" Med Black
- #105-WVR-49303 1" Med Matte
- #105-WVR-49304 1" High Black
- #105-WVR-49305 1" High Matte
- #105-WVR-49306 1" X-High Black
- #105-WVR-49307 1" X-High Matte
- #105-WVR-49321 1" Med Silver
- #105-WVR-49322 1" High Silver
- #105-WVR-49323 1" X-High Silver
- #105-WVR-49313 1" Med Black .22 Rifle
- #105-WVR-49314 1" High Black .22 Rifle

Weaver Grand Slam Steel .22 and Ruger 77

Grand Slam Rings are constructed of solid steel which yields amazing strength and scope retention.



- #105-WVR-49216 1" .22 Med Gloss Blk
- #105-WVR-49217 1" .22 Med Matte Blk
- #105-WVR-49215 1" .22 Med Nickel
- #105-WVR-49212 1" .22 High Gloss Blk
- #105-WVR-49213 1" .22 High Matte Blk
- #105-WVR-49214 1" .22 High Nickel
- #105-WVR-49218 1" .22 X-High Gloss Blk
- #105-WVR-49219 1" .22 X-High Matte Blk
- #105-WVR-49221 1" .22 X-High Nickel
- #105-WVR-49236 1" Ruger #1 77/22 Med Blk
- #105-WVR-49234 1" Ruger 77 Med Gloss Blk
- #105-WVR-49232 1" Ruger 77 High Gloss Blk
- #105-WVR-49233 1" Ruger 77 High Matte Blk
- #105-WVR-49231 1" Ruger 77 High Nickel

Sure Grip

Snap tight container of rosin that prevents your scope from slipping in rings
#LLR-SGR-NR1



Weaver Grand Slam Steel Dovetail Extension Rings

Adjust the eye relief on your favorite scope. These solid, all-steel rings allow you to move your scope forward or back for optimum placement.



- #105-WVR-49222 1" STR XTF Med Black
- #105-WVR-49210 1" STR XTF High Black
- #105-WVR-49224 1" XTR XTF Med Black
- #105-WVR-49228 30MM STR, XTF High Black
- #105-WVR-49229 30MM STR, XTF High Matte

Weaver Grand Slam Steel Lever-Lok Rings

The quick detach feature makes this ring an ideal choice for the serious hunter on the go. This durable, reliable ring easily detaches and re-mounts without tools so you can protect your optics while traveling to your next hunt. The reliable Weaver cross lock design allows for secure, tight fit on your favorite rifle. With solid steel construction, you can rest assured that this ring will perform in the heat of the hunt.



- #105-WVR-49325 1" Med Matte
- #105-WVR-49326 1" High Matte
- #105-WVR-49327 1" X-High Matte
- #105-WVR-49328 1" Med Black
- #105-WVR-49329 1" High Black
- #105-WVR-49330 1" X-High Black
- #105-WVR-49336 30mm High Black

Weaver See-Thru Rings

Utilize iron sights or your scope for quick target acquisition with these convenient rings. The square cross lock bolt fits tightly and securely with Weaver top mount bases.



- #105-WVR-49513 1" Black
- #105-WVR-49523 1" Matte
- #105-WVR-49522 1" Silver
- #105-WVR-49514 1" Gloss for .22 rifles
- #105-WVR-49517 1" Silver for .22 rifles
- #105-WVR-49512 1" EXT Black
- #105-WVR-49510 1" EXT Matte
- #105-WVR-49524 1" DUAL EXT Black
- #105-WVR-49525 1" DUAL EXT Matte

Weaver Tactical Scope Rings

In the tactical world, performance is mandatory—there is no compromise. Whether it's intense training or real-life action, you need your zero to stay true. These aircraft-grade aluminum tactical rings feature six points of contact for maximum security and are designed to withstand the most grueling environments imaginable. If you demand the most from your tactical scope, demand Weaver.



- #105-WVR-48350 1" High Matte
- #105-WVR-48351 1" X-High Matte
- #105-WVR-48352 30mm High Matte

Weaver Tactical Flat Top Riser Rail - Quick Detachable

Made from aircraft-grade 6061-T6, aluminum and has Type III hard coat anodizing for years of rugged use. Engineered to provide the optimal mounting height for all types of optic and ring combinations, the new Flat Top Riser Rail is available in both standard and quick detach models.



#105-WVR-99659

Samson 30mm Quick Flip Optics Rings

Heavy duty 30mm rings in the Samson Quick Flip Mount. Perfect mount for universal optics magnifiers and other accessories.

#SMC-QF-30-RM



Weaver Sure Grip Windage Adjustable

The four-screw system and steel cap offer shot-of-a-lifetime dependability. Windage adjustable models ensure that zeroing in your scope to critical accuracy is certain.



- #105-WVR-49140 1" Med Black
- #105-WVR-49143 1" Med Matte
- #105-WVR-49141 1" High Black
- #105-WVR-49144 1" High Matte
- #105-WVR-49142 1" X-High Black
- #105-WVR-49145 1" X-High Matte

Weaver Standard Detachable Rings

Get the best of both worlds with a steel strap for added strength and an aluminum saddle for reduced weight. These quick detach rings are the original Weaver style rings.



- #105-WVR-49030 1" Low Gloss Blk
- #105-WVR-49040 1" Low Matte Blk
- #105-WVR-49034 1" Low Silver
- #105-WVR-49071 1" Med Gloss Blk
- #105-WVR-49041 1" Med Matte Blk
- #105-WVR-49032 1" Med Silver
- #105-WVR-49050 1" High Gloss Blk
- #105-WVR-49042 1" High Matte Blk
- #105-WVR-49033 1" High Silver
- #105-WVR-49080 1" X-High Gloss Blk
- #105-WVR-49044 1" X-High Matte Blk
- #105-WVR-49036 1" X-High Silver
- #105-WVR-49819 1" Med Gloss .22 Rifle
- #105-WVR-49039 1" Med Silver .22 Rifle
- #105-WVR-49821 1" Med Silver .22 Airsoft
- #105-WVR-49122 30mm Low Gloss Blk
- #105-WVR-49121 30mm Low Matte Blk
- #105-WVR-49131 30mm Low Silver
- #105-WVR-49110 30mm High Gloss Blk
- #105-WVR-49120 30mm High Matte Blk
- #105-WVR-49130 30mm High Silver

PRI Tactical Steel Rings

- 4140 Steel Construction
 - Parkerized Finish
 - 1/4"x 28 -1/2" Locking Nut
 - 4 Torx Head Top Screws
 - Designed to withstand the recoil of a 50 cal. rifle with ease
 - Designed to mount on Standard or Mill Spec Rails
- #ROP-001-010 1" Standard Height: .875"
 #ROP-003-010 30mm Standard Height: .965"
 #ROP-003-020 30mm Extra High Height: 1.34"



(Measured from the center of the optic to the base)
Replacement Top Screws available:
 #ROP-001-011 Top Screws 1"
 #ROP-003-011 Top Screws 30mm



PRI 1" Standard Rings



PRI 30mm Standard Rings



PRI 30mm Extra High Rings

PRI Tactical Aluminum Rings

- 7075 hard coat black anodized aluminum construction
 - Parkerized Finish
 - 1/4"x 28 -1/2" Locking Nut
 - 4 Torx head top screws
 - Designed to withstand the recoil of a 50 cal. rifle with ease
 - Designed to mount on Standard or Mill Spec Rails
- #ROP-ALP-30S 30mm Standard Height: .965"
 #ROP-ALP-30H 30mm Extra High Height: 1.34"

(Measured from the center of the optic to the base)



PRI 30mm Aluminum Standard Rings



PRI 30mm Aluminum Extra High Rings



PRI Ring Inserts
 #ROP-INS-11N 30mm to 1"
 #ROP-INS-026 30mm to 26mm

PRI 30mm High Rings, 50 Caliber

- Designed for 50 Caliber Shooters
 - 4140 Steel Construction/Torx Screws
- #ROP-50C-301 6 screw rings



PRI 30mm Ex High Rings-25MOA

- Designed for Long Distance Shooters with 25MOA
 - 4140 Steel Construction/Torx Screws
- #ROP-003-025 4 screw rings



PRI 30mm High Rings, 50 Caliber-25MOA

- Designed for 50 Caliber Shooters with 25 MOA
 - 4140 Steel Construction/Torx Screws
- #ROP-50C-325 6 screw rings

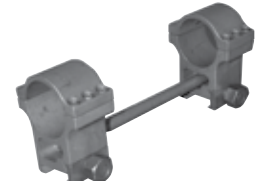

PRI 34mm High Rings-25MOA

- 4140 Steel Construction
 - Torx Screws, 25 MOA and spacer bar
- #ROP-034-025



PRI 34mm High Rings

- Designed to mount on 56mm Objective on a Straight Rail
 - 4140 Steel Construction/Torx Screws
- #ROP-034-010 4 screw rings



PRI 40mm High Rings

- 4140 Steel Construction/Torx Screws
 - Designed to withstand the recoil of a 50 cal. rifle with ease
- #ROP-040-040



Nightforce Ultralite 30mm Scope Rings

When a tough, reliable mounting system is required without adding substantial weight, Nightforce Ultralite rings are the answer. They feature CNC machined 7075-T6 hard anodized black aluminum bodies and titanium beta series crossbolts and jaws. This unique construction provides exceptional strength, normally not found in lightweight rings. Testing has proven that this combination is actually stronger than steel.

#117-NF-885UL	Low Rings	.885"
#117-NF-100UL	Medium Rings	1.00"
#117-NF-1125UL	Medium Rings	1.125"

(Measured from the center of the optic to the base)



Barrett's 50 Cal 30mm Scope Rings

Barrett's ZERO-GAP, tight-toleranced collet design makes these rings easy to use. They provide definitive holding power for heavy scopes under the harshest recoil.

- For use with 30mm rifle scope tubes on Mil Std 1913 accessory rails
- 1.2" wide clamping area positively grips without damaging scope tube

HRB-30MM-LOW	30mm Low Rings	Height: 1."
HRB-30MM-MED	30mm Med Rings	Height: 1.1"
HRB-30MM-HIGH	30mm High Rings	Height: 1.3"
HRB-30MM-ULHI	30mm Ultra High	Height: 1.4"

(Measured from the center of the optic to the base)

Nightforce Unimount 30mm Scope Rings w/ 20 MOA

Designed to remain on the scope at all times, allowing quick removal of the scope or interfacing with different firearms. It is the most accurate Picatinny Mil. Std. 1913 mount available, incorporating a built-in 20 M.O.A. taper to maximize long-range capability.

#117-NF-UNIMTUL-1125	Medium Rings	1.125"
#117-NF-UNIMTUL-1375	High Rings	1.375"

(Measured from the center of the optic to the base)



Barrett 30mm ExRings

Barrett ExRings with Pin-Lock technology is a dual setting MOA extended range ring set that utilizes the riflescope's precise internal elevation adjustment by aligning the scope for long range shooting. Barrett's ZERO-GAP technology provides definitive holding power for heavy scopes under the harshest recoil.

Purpose: To maximize the riflescope's precise internal elevation adjustment by angling the scope without compromising the rigidity of a one piece mount.
 #HRB-30MM-EXR



Nightforce Anti-Cant Device Top Ring Bubble Level



This anti cant device from Nightforce features a bubble level to show the shooter if they are canting to the left or right. The device is only for use with the Nightforce Unimount, Direct Mount or Steel Rings.
 #117-NF-BAPLVL



Barrett 1" Scope Ring Adapters

1" scope ring adapters, 82124-AD1, are used to adapt 30mm rings for use with a 1" scope. Four adapters are required per scope.
 #HRB-1IN-INS Set of 4

A.R.M.S. #22 30mm Rings

All Steel 30mm Ring, secured with A.R.M.S. dovetail system to an extruded aluminum platform.

- #ARMS-22L 30mm Low Height: .925"
 - #ARMS-22M 30mm Medium Height: 1.150"
 - #ARMS-22H 30mm High Height: 1.450"
- (Measured from the center of the optic to the base)



A.R.M.S. #22L Rings



A.R.M.S. #22M Rings



A.R.M.S. #22H Rings

A.R.M.S. #35 30mm Rings

The A.R.M.S. #35 rings attach to A.R.M.S. rail foundations that have stainless steel helicoil threaded holes imbedded into the center channel of the rail between the Mil-Spec dovetail rails, allowing perfect solid alignment.

- #ARMS-35L 30mm Low Height: .900"
 - #ARMS-35M 30mm Medium Height: 1.25"
 - #ARMS-35H 30mm High Height: 1.50"
- (Measured from the center of the optic to the base)



A.R.M.S. #35L Rings



A.R.M.S. #35M Rings



A.R.M.S. #35H Rings

A.R.M.S. #35QD Throw Lever Mount

For those who already use the A.R.M.S. #35 Track Mounting Rings with the A.R.M.S. #36 OSR Sleeves, #39 A2 Plus Mount, we now provide the first Modular Track Mounting Throw Lever Rail System in the market place. This magnificent system will allow the soldier or sportsman to accommodate virtually any 30mm optic and in perfect track alignment from Ultra Low to Extra High rings for those very large objective lenses.

#ARMS-35QD

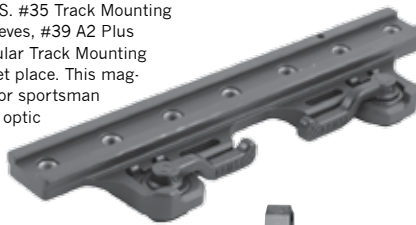

Scope mounted with #35QD Base and #35 Medium Rings

A.R.M.S. #21 STANAG 30mm Rings

The #21™ Rings are all steel with a Mil-spec phosphate finish for ultimate surface protection. Available in Low height.

#ARMS-21



A.R.M.S. #21 STANAG 30mm Rings shown on a A.R.M.S. #19 Dovetail/STANAG Mount

A.R.M.S. #6

Adapter, Converts NATO STANAG to Mil-Spec 1913
#ARMS-06



A.R.M.S. #7

Adapter, Mounts NATO STANAG Scopes on Weaver type rail.
#ARMS-07

A.R.M.S. #19 Dovetail/STANAG Mount

Aluminum base secured by steel feet & levers with A.R.M.S. No-mar patented buffer pads. Interfaces to M16 A1, A2, M4, also Stinger & AT-4 when M16 mount is used in the AT-4 & stinger brackets. Provides universal platform, which is the NATO STANAG and Weaver standards combined for many day and night vision optics & lasers. Guaranteed repeat zero hold.

#ARMS-19

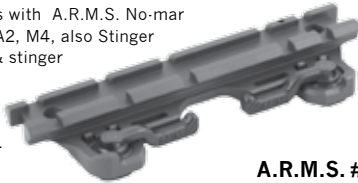

A.R.M.S. #22TRC

Tactical Ring Cap
(Shown on #22 Ring)
#ARMS-22TRC



A.R.M.S. #22TRS

Tactical Rail Sight
(Shown on #22 Ring Cap)
#ARMS-22TRS



A.R.M.S. #63

Combines all the features of the #5 with the #19!! Provides 3/4" of additional height for mounting optics with large objective lenses. Compatible with STANAG mounts and features a see-through channel for use with iron sights.

#ARMS-63



See Thru Mount

Adds 3/4" in height

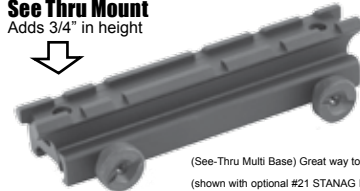

(See-Thru Multi Base) Great way to mount on #3's and #4's (shown with optional #21 STANAG Rings)

A.R.M.S. #22-34 Ring

34mm Scope Rings
#ARMS-22-34

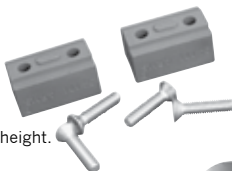

A.R.M.S. #22TRR

Tactical Ring Rail
(Shown on #22 Ring with Ring Cap)
#ARMS-22TRR

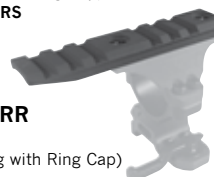

A.R.M.S. #22-34SP

Optional spacer for additional height.
#ARMS-22-34SP



A.R.M.S. Ring Inserts #37

The #37™ Ring inserts are all steel with a Mil-spec phosphate finish, for ultimate surface protection. Converts all A.R.M.S. and other 30mm rings to 1". (Sold as a pair)
#ARMS-37

A.R.M.S. #5 Multi-Base

Quick detachable, multiple eye relief, spring loaded clamping bar, iron sight see-thru. NATO STANAG and Weaver rail fastening, self-locking captivated thumbnuts.
#ARMS-05





MSP Variable Eye Relief Scope Mount and 30mm Rings with MOR Rail

Your option:

- Six or more rail positions for eye relief (the 9" rail has even more optional mounting positions)
- Some available in longer lengths and with MOA
- Attaches to any mil-spec rail
- Additional spacers are available for the #35 Rings to add even more height if you have a large objective on your scope or need extra height
- Modified versions available for long and short action rifles and some two piece bases
- Ideal for mounting scopes for optimal functionality and eye relief comfort

Kit Includes:

- 6" or 9" Eye Relief Rail (9" length available in straight or with 15, 20, 25 or 30 MOA)
- A.R.M.S. #35QD Rail
- A.R.M.S. #35L 30mm Scope Rings

- #MOA-ER-SET-6-0 30mm Rings with 6" Straight Rail
- #MOA-ER-SET-9-0 30mm Rings with 9" Straight Rail
- #MOA-ER-SET-9-15 30mm Rings with 9" 15 MOA Rail
- #MOA-ER-SET-9-20 30mm Rings with 9" 20 MOA Rail
- #MOA-ER-SET-9-25 30mm Rings with 9" 25 MOA Rail
- #MOA-ER-SET-9-30 30mm Rings with 9" 30 MOA Rail



MSP Add-A-Rail System

Mounts Top/Bottom or Side Mounting Options

Tactical Forearm Rail Kit

TOP or BOTTOM Mount (Mil-Spec Dimensions)

- Rail Mounted Bi-Pods
- Flashlights
- Many other uses

For use with factory standard A-2 and M4 forearms.

Designed to allow use of a detachable light, vertical foregrip, or other rail mounted accessories.

#LLR-TFR-NR1

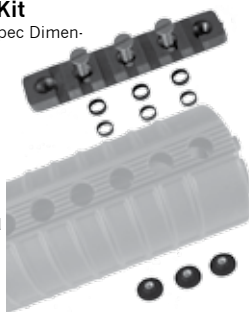

Examples of uses for Add-A-Rail System...



Tactical Forearm Rail Kit

SIDE Mount (Mil-Spec Dimensions)

For use with factory standard, A-2 and M4 forearms. Designed to allow use of a detachable light or other rail mounted accessories.

#LLR-TFR-NR4

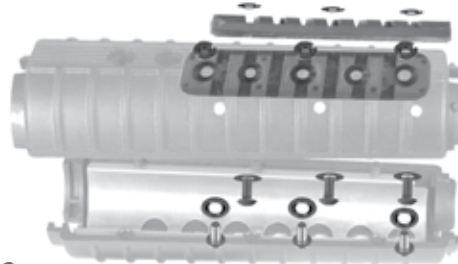

Double Picatinny Rail

For custom mounting solutions

#LLR-TFR-DPR

Modified A.R.M.S. #35QD

Throw-lever repeatability & maintainability two-piece unit for any mil-spec 1913 rail
Multiple positions of throw levers for long and short action rifles & variable eye relief. Most versatile system available today! Adds .75" to height.

#MOA-A35-002



MSP 9" MOA Rail

Rail with built-in MOA, designed to fit the #35QD Dual Throw lever base.

- #MOA-PAL-000 9" Straight Rail
- #MOA-PAL-015 9" 15 MOA Rail
- #MOA-PAL-020 9" 20 MOA Rail
- #MOA-PAL-025 9" 25 MOA Rail
- #MOA-PAL-030 9" 30 MOA Rail



(For extra eye relief... Use our 9" straight rail)

MSP 9" MOA Rail with Modified A.R.M.S. #35QD

A combination of A.R.M.S. #35QD Dual Throw Lever Scope Mount Base cut in two with a MOA Rail for long distance shooter.

- #MOA-SET-T00 9" Straight Rail
- #MOA-SET-T15 9" 15 MOA Rail
- #MOA-SET-T20 9" 20 MOA Rail
- #MOA-SET-T25 9" 25 MOA Rail
- #MOA-SET-T30 9" 30 MOA Rail



Gunsmith Kit for Add-A-Rail System

Rail Gunsmithing Kit Contains:

- 10 Rails
- 15 Well Nuts
- 15 Well Nut Small Bushings
- 15 Well Nut Large Bushings
- 15 Socket Cap Screws
- 15 Button Head Cap Screws
- 12 Reverse Countersink Filler Nuts
- 15 Large Curved Washers
- 15 Small Curved Washers
- 1 Hex Wrench
- 1 Drill Bit
- 1 Spanner Wrench
- 1 Instruction Manual

#LLR-TFR-NR3



Reverse Countersunk Nuts and Wrench

(Mil-Spec Dimensions)

For use on installation of rails which have tapered countersunk holes. Kit contains 12 nuts (#8/32 threads) and one wrench.

#LLR-GST-001



Tactical Forearm Rail

Rail only, no hardware.

(See Gunsmithing Sections for Armor's Kit)

#LLR-TFR-NR2

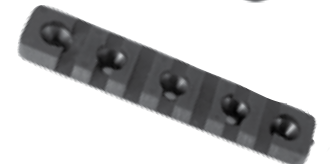



A.R.M.S. #16
30MM red dot mount
#ARMS-16T Trijicon®
Tri-Power Mount
#ARMS-16A Aimpoint Mount
(Shown with Aimpoint Sight)



Weaver AR-15 Carry Handle/Sight
Add a Carry Handle to your Flat top
#105-WVR-48326 Flat Top Mount



Weaver AR-15 Carry Handle Mount
Picatinny style rails accepts Weaver Top Mount Rings to secure your optics.
#105-WVR-48320



Weaver AR-15 Flat Top Single Rail Mount
Picatinny style rails accepts Weaver Top Mount Rings to secure your optics.
#105-WVR-48321



Weaver AR-15 Tri-Rail Mount
Picatinny style rails accepts Weaver Top Mount Rings to secure your optics. Utilize the Tri Rail design to mount a variety of accessories including tactical lasers or flashlights.
#105-WVR-48323 Flat Top Mount
#105-WVR-48322 Carry Handle Mount

Original A.R.M.S. #2
M16A1A2 Scope Mount
NSN58550129977
#ARMS-02



A.R.M.S. #2E
M16A1A2 / AR10 Extended (6.5 in. long)
#ARMS-02E



A.R.M.S. #39 A2 PLUS Mod Mount
#39 is designed to use either the new track mounted rings, throw lever rings, or any ring designed to work on a mil-spec rail.
#ARMS-39



PRI M16/AR15 Standard Carry Handle Mount
A1/A2 DUAL-WITNESS HOLOGRAPHIC
The mounting rail is sufficiently low to allow the iron sights to be cointitnessed with the red dot of the optical sight. The standard model fits on most standard issue firearms.
#SAM-3AH-OLO



PRI AR-15 High Rider Carry Handle Mount
High Rider Carry Handle Mount, see specs on Standard Model, The HR model sits higher to accommodate the larger specialized firearms available as retrofits.
#SAM-3BH-IGH

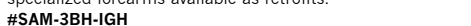

A.R.M.S. #17
Original Tri-Loc Mount
#ARMS-17



A.R.M.S. #17-S
Short Version
#ARMS-17S



A.R.M.S. #17-DR
Original With Dove Tail Rail
#ARMS-17DR



A.R.M.S. #17 PEQ2
Single Lever Platform Mount
#ARMS-17PEQ2



A.R.M.S. #17DL
Dual Throw Lever® Mount attaches to the SureFire® M900-series weaponlight.
#ARMS-17DL



PRI Base w/Knurled Thumb Knob
#PRI-KTN-017



IMS (Interchangeable Mounting Systems)

A multiple size mounting system based on a small platform (common to many manufacturers) with many add on features. Attachments range from flat to angular rails, sling swivels, Docter Optic style interfaces and even leveling devices for accurately mounting scopes and ACD's. More attachments coming soon.

PART NUMBERS:

- 1 #IMS-S71-001-BAS Thumbscrew platform common to all attachments.
- 2 #IMS-S71-002-45U 45° mounting adaptor extending above the S71 base
- 3 #IMS-S71-003-45D 45° mounting adaptor offset and below the S71 base.
- 4 #IMS-S71-004-90U 90° mounting adaptor extending above the S71 base.
- 5 #IMS-S71-005-RAL 1913 rail attaching to S71 base and all angular adaptors
- 6 #IMS-S71-006-SSS Sling swivel stud attaching to the S71 base and all angular adaptors
- 7 #IMS-S71-007-BYU Blank steel plate attaching to the S71 base and all angular adaptors. Build your own special mount.
- 8 #IMS-S71-008-DOA Docter Optic style mount attaching to the S71 base and all angle adaptors.
- 9 #IMS-S71-009-LVL Multi plane level attaching directly to the S71 base action level for precision scope , scope optic and ACD mounting.
- #IMS-S71-010-RSR 1/8 inch riser for S71 base and mounts.
- #IMS-S71-SET-B01 S71 base with build your own adaptor.
- 10 #IMS-S71-SET-B45U S71 base with 45° up adaptor and build your own mount.
- 11 #IMS-S71-SET-B45D S71 base with 45° down adaptor and build your own mount.
- 12 #IMS-S71-SET-B90 S71 base with 90° adaptor and build your own mount.
- 13 #IMS-S71-SET-R01 S71 base with 1913 rail.
- #IMS-S71-SET-R45U S71 base with 45° up adaptor and rail and 1913 rail.
- #IMS-S71-SET-R45D S71 base with 45° down adaptor and 1913 rail.
- #IMS-S71-SET-R90U S71 base with 90° adaptor and 1913 rail
- #IMS-S71-SET-S01 S71 base with sling swivel stud
- #IMS-S71-SET-S45U S71 base with 45° up adaptor and sling swivel stud
- #IMS-S71-SET-S45D S71 base with 45° down adaptor and sling swivel stud
- #IMS-S71-SET-S90 S71 base with 90° adaptor and sling swivel stud.
- #IMS-S71-SET-DO1 S71 base with Docter Optic style mount
- #IMS-S71-SET-D45U S71 base with 45° up adaptor and Docter Optic style mount.
- #IMS-S71-SET-D45D S71 base with 45° down adaptor Docter Optic style mount.
- #IMS-S71-SET-D90 S71 base with 90° adaptor and Docter Optic style mount.
- #IMS-S71-SET-LVL S71 base with level



- #IMS-S71-SET-CON Convert Samson platform to S71 screws
- #IMS-L71-001-BAS Large thumb screw platform common to all attachments.
- #IMS-L71-005-RAL 1913 rail attaching to the L71 base.
- #IMS-L71-010-SRS 1/8" riser for L71 base.
- #IMS-L71-006-SSS L71 base with sling swivel stud.
- #IMS-L71-007-BYU Blank steel plate attached to the L71 base-build your own special mount.
- #IMS-L71-SET-BY1 L71 base with steel build your own adaptor.
- #IMS-L71-SET-R01 L71 base with 1913 rail.
- #IMS-L71-SET-SO1 L71 base with sling swivel stud adaptor.

Weaver Tactical Flat Top Riser Rail - Quick Detachable

Made from aircraft-grade 6061-T6, aluminum and has Type III hard coat anodizing for years of rugged use. Engineered to provide the optimal mounting height for all types of optic and ring combinations, the new Flat Top Riser Rail is available in both standard and quick detach models.
#105-WVR-99659



A.R.M.S. #63

Throw lever riser mount
#ARMS-63



See Thru Mount
Adds 3/4" in height

A.R.M.S. #5 Multi-Base

Spring loaded clamping bar Iron sight see-thru self-locking thumbnuts increases height: .725"
#ARMS-05



(See-Thru Multi Base) Great way to mount on #3's and #4's (shown with optional #21 STANAG Rings)

A.R.M.S. #19 Dovetail/STANAG Mount

Aluminum base secured by steel feet & levers with A.R.M.S. No-mar patented buffer pads. Interfaces to M16 A1, A2, M4, also Stinger & AT-4 when M16 mount is used in the AT-4 & stinger brackets. Provides universal platform, which is the NATO STANAG and Weaver standards combined for many day and night vision optics & lasers. Guaranteed repeat zero hold.
#ARMS-19

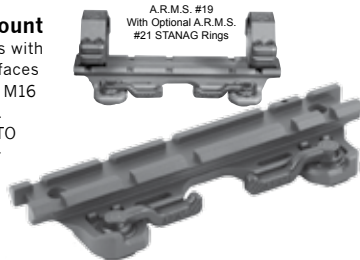

A.R.M.S. #19
With Optional A.R.M.S. #21 STANAG Rings

PRI Top Rail Riser

Originally designed to set on the M4 flattop receiver but it has proved to be a versatile base for many different purposes. The aluminum rail lifts the mounting surface up .450" and allows the extension to the front or rear of 1.500".

#PRI-050-062 Riser 2 Hole
#PRI-050-064 Riser 3 Hole

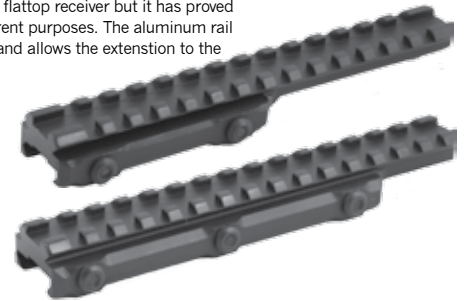

A.R.M.S. OSR-Optical Sight Rails

Adds .5" in height

A.R.M.S. #36 EX

M16/M4 Flat Top Receiver Optical Sight Rail
Length 8.460"
#ARMS-36-EX

A.R.M.S. #36 S-EX

M16/M4 Flat Top Receiver Optical Sight Rail
Length 14"
#ARMS-36S-EX



A.R.M.S. #36 STD-AR10

AR-10 Flat Top Receiver Optical Sight Rails
Length 8.460"
#ARMS-36STD-AR10

A.R.M.S. #36 SEX-AR10

AR-10 Flat Top Receiver Optical Sight Rails
Length 14"
#ARMS-36SEXAR10

A.R.M.S. #36 EX-AR10

AR-10 Flat Top Receiver Optical Sight Rails
Length 9.5"
#ARMS-36EX-AR10

SWAN Sleeves for M16/M4 Flat Top Receivers

Flip-Up Sight Included, Adds .5" in height

A.R.M.S. #38 STD SWAN Sleeves 556

Standard Receiver Length 8.37"
#ARMS-38-STD

A.R.M.S. #38 EX

Length: 8.460"
#ARMS-38-EX

A.R.M.S. #38 S-EX

Length: 14"
#ARMS-38-S-EX



SWAN Sleeves for AR-10 Flat Top Receivers

Flip-Up Sight Included, Adds .5" in height

A.R.M.S. #38 STD AR-10

Standard Receiver Length: 8.37"
#ARMS-38-STD-AR10

A.R.M.S. #38 EX AR-10

Length: 9.75"
#ARMS-38-EX

A.R.M.S. #38 S-EX

Length: 14"
#ARMS-38-S-EX



A.R.M.S. S.I.R. #1 Rail

Original Replacement
#ARMS-1RAIL



A.R.M.S. S.I.R. #2 Rail

Original Replacement
#ARMS-2RAIL



A.R.M.S. S.I.R. #3 Rail

Original Replacement
#ARMS-3RAIL



A.R.M.S. S.I.R. #4 Rail

#ARMS-4RAIL



A.R.M.S. S.I.R. #50

Optional PEQ-2 #50
#ARMS-SIR-50003



A.R.M.S. S.I.R. Optional Top Rail #50

#ARMS-SIR-50002



A.R.M.S. S.I.R. #59

Top Rail for Bi-level
#ARMS-SIRRAIL59-0003



#A.R.M.S. S.I.R. Swivel

Original Replacement
#ARMS-SIR-RAILSWI



A.R.M.S. #40

Flip Up Rear Sight
Optional Accessory
#ARMS-40

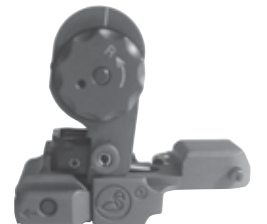



A.R.M.S. SPARTAN RAIL

- Lightweight modular rail system specifically designed to accept a variety of advanced lighting and laser modules into the rail system with minimal increase in the weapons size or signature
- Modular control surfaces allow intuitive and reliable placement of activation buttons without adhesives
- Proprietary design allows for exceptionally strong and precise mounting on M4 platforms using the standard barrel nut
- Available in Carbine and Mid Length systems

#ARMS-56M-CV-C Carbine Rail
#ARMS-56M-CV-EXT Mid Length Rail



A.R.M.S. S.I.R. SYSTEMS

Selective Integrated Rail® System

A.R.M.S. S.I.R. System can provide a multitude of modular capabilities for accessories like: thermal imager, lasers, night vision, optical sight, M203, etc. The A.R.M.S. S.I.R. System has more unique and helpful features for the professional user than all other devices combined. Only the A.R.M.S. S.I.R. System allows you to have dovetail rails where you want them and not where someone else decided for you.

No other system keeps the weapon as cool during firing as the A.R.M.S. S.I.R. System. No more hot, uncomfortable dovetail rails to deal with like on other systems. The A.R.M.S. S.I.R. System has a true free float barrel that does not require the barrel to be removed during installation, like on other tube designs. A unique quick change polymer hand-guard allows easy access to clean the barrel without removing the system or barrel. The S.I.R. System works with any type front sight you may have. No special tools are required to install. A coin is all that is needed.

The S.I.R. allows for the attachment of different sized rails to customize your S.I.R.® system. The S.I.R. System comes stock with one each of the #1, #2, and #3 rails which can be interchanged into many different configurations on the hand-guard. If a rail is not being utilized, simply remove it until needed to save on weight. The longer #4 rail is also available. The S.I.R. System allows multiple attachments tailored to the needs of the user's mission.



A.R.M.S. S.I.R. #50C/TR

Carbine/with Top Rail
#ARMS-50C-TR

Lower Level Ideal for EoTech

A.R.M.S. S.I.R. #50C

Carbine/Bi-Level
#ARMS-50C

A.R.M.S. S.I.R. #50M

Carbine/Bi-Level
#ARMS-50M

A.R.M.S. S.I.R. #50M/TR

Carbine/with Top Rail (Not shown)
#ARMS-50M-TR

A.R.M.S. S.I.R. #58M-CV MOD

Modified Mid-Length for Carbine
#ARMS-58-M-CV-MOD

A.R.M.S. S.I.R. #58M CV

Mid-Length
#ARMS-58M-CV



A.R.M.S. S.I.R. #51

A-2 Carry Handle
#ARMS-51

A.R.M.S. S.I.R. #50M-CV

Carbine Length
#ARMS-50M-CV

A.R.M.S. #50CV03

Adds to A.R.M.S. #50M-CV to make rails same height

#ARMS-50CV03

A.R.M.S. S.I.R. #59C Rifle

#ARMS-59C

A.R.M.S. S.I.R. #59M Rifle

#ARMS-59M

Samson STAR-4-DI
AR Pistol Drop-In-Rail. Pistol Length
#SMC-DRO-4IN



Samson STAR-4
AR Pistol Carbine Free Floating Rail,
#SMC-ARP-4IN



Samson STAR-DI
AR-15 Drop-In-Rail. Carbine Length
#SMC-DRO-PIN



Samson STAR-C
AR-15 Carbine Free Floating Rail,
#SMC-C00-007



Samson STAR-CX
AR-15 Carbine Free Floating Rail w/ front sight cutout
#SMC-CX0-010



Samson STAR-CX-EBR
AR-15 Carbine Free Floating Rail w/ front sight cutout,
#SMC-CMO-EBR



Samson STAR-M
AR-15 Mid-Length Free Floating Rail
#SMC-009-MID



Samson STAR-MX
AR-15 Mid-Length Free Floating Rail
#SMC-CMX-010



Samson STAR-M-EX
AR-15 Mid-Length Rail
#SMC-MEX-000

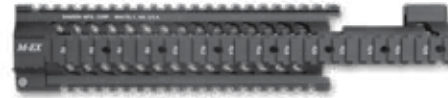

Samson STAR-MEX-EBR
AR-15 Mid-Length Free Floating Rail
#SMC-MEX-EBR



Samson STAR-R
AR-15 Rifle Length Free Floating Rail
#SMC-012-004



Samson STAR10-7.2"
AR-10 Carbine Free Floating Rail
#SMC-10-7.2



Samson STAR10-9.2"
AR-10 Mid-Length Free Floating Rail
#SMC-10-9.2



Samson STAR10-13.2"
AR-10 Rifle Length Free Floating Rail
#SMC-10-13.2



Samson STAR SIG 556
Built for the Sig 556, the STAR-556 is available in both three and four mounting hole versions. With a 19" top rail, optics and accessory mounting couldn't be easier. the Sig 556 is THE Sig rail to own.
#SMC-SIG-556-3 Rail 3-hole model
#SMC-SIG-556-4 Rail 4-hole model



Samson STAR SIG 556 Pistol & SBR
Built for the Sig 556 pistol, the STAR-556-S has a full length continuous top rail. Optics and accessory mounting couldn't be easier.
#SMC-SIG-556-S



PRI GEN III Carbon Fiber Upper

The Latest PRI Gen III free float forearm and barrel nut are constructed of light weight, high strength carbon fiber, aluminum, and high strength steel for the best possible combination of weight and strength. The carbon fiber also reduces the amount of heat transferred to the shooter's hand during rapid or high volume firing. The long top rail matches the height of the top rail on the standard flattop receiver and is compatible with the ARMS family of rails.

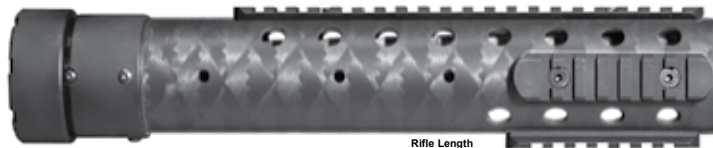
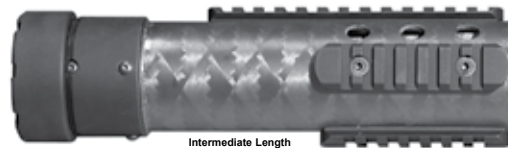

Carbine Length

- #PRI-03-072-01B AR-10, Black for Armalite
- #PRI-03-072-01N AR-10, Natural for Armalite
- #PRI-03-072-12B AR-10, Black for DPMS
- #PRI-03-072-12N AR-10, Natural for DPMS
- #PRI-05-073-01B AR-15, Black
- #PRI-05-073-01N AR-15, Natural

Intermediate Length

- #PRI-05-073-02B AR-15 Black
- #PRI-05-073-0BN AR-15, Natural

Rifle Length

- #PRI-PRI-03-072-03B AR-10, Black for Armalite
- #PRI-PRI-03-072-03N AR-10, Natural for Armalite
- #PRI-PRI-03-072-14B AR-10, Black for DPMS
- #PRI-PRI-03-072-14N AR-10, Natural for DPMS
- #PRI-PRI-03-072-1415B AR-10, 15" Black for DPMS
- #PRI-PRI-03-072-1415N AR-10, 15" Natural for DPMS
- #PRI-05-073-03B AR-15, Black
- #PRI-05-073-03N AR-15, Natural
- #PRI-05-073-14N AR-15, 14" Natural
- #PRI-05-073-15N AR-15, 15" Natural

PRI GEN III Forearm Rail

AR15/M16 PRI Forearm Rail Intermediate Length. The PRI rail is constructed of light weight aluminum. The rail is made to work with the PRI free float forearm. The 1913 rail ties the upper receiver to the forearm to make a rigid platform for mounting any sighting or lighting equipment required.

- #PRI-FRC-200 Carbine Length
- #PRI-FRI-150 Intermediate Length
- #PRI-FRL-100 Rifle Length

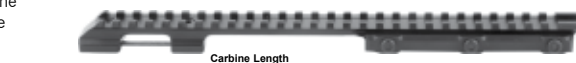

Replacement Forearm Rail

- #PRI-CFU-074 3" long
- #PRI-CFU-075 8.5" long

A.R.M.S. #38 SPR-PEQ

This sleeve provides a one piece mounting platform that ties the forearm and upper receiver into one rigid shooting system.

- #ARMS-38-SPR-PEQ-2

PRI Barrel Nut Wrench

This wrench allows the shooter to put the exact amount of pressure needed on the barrel nut while attaching the barrel to the receiver.

- #PRI-05-0082 For the AR-15
- #PRI-03-0085 For the Armalite AR10
- #PRI-03-0086 For the DPMS / KAC 308



PRI GenIII Forearm Wrench

Gen III AR15 M16 Forearm Wrench for assembling carbon fiber forearm to upper receiver.

- #PRI-05-0081 For the AR-15
- #PRI-03-0081 For the AR-10



Rifle Length



Intermediate Length

PRI Gen III Delta Carb Fiber Forearm

Designed for most piston or op-rod systems

This new Free-Floated Carbon Fiber forearm is in the triangular shape, (Delta) configuration and was designed to work with most piston or op-rod systems out in the market today. The Delta forearm uses the same easy locking system as the original round tubes. The forearms come in Black or Dark Earth colors. The forearm comes with 4 rails, 1 rail on top and then 3 rails at 3,6 and 9 O'clock positions. The forearm is constructed of wrapped carbon fiber, with an aluminum barrel nut and collar. The receiver and the rail on forearm are not at the same elevation. The inner diameter of the barrel nut is 1.020".

Carbine Length

- #PRI-05-071-03B AR-15 Black
- #PRI-05-071-03DE AR-15, Dark Earth

Intermediate Length

- #PRI-05-071-02B AR-15 Black
- #PRI-05-071-02DE AR-15, Dark Earth

Rifle Length

- #PRI-05-071-01B AR-15 Black
- #PRI-05-071-01DE AR-15, Dark Earth



ATI AR-15 Carbine Two Piece Forend Combo Rail Package

Give your AR-15 some personality with ATI's new 8 sided forend. Insert rails at 45° angles around the circumference of the forend for ultimate versatility! Additionally, slide rails in any position on the forend for nearly unlimited customization.

Features of Forend:

- Rail locations at 45° increments around forend
- Millions of rail configurations
- Put accessories exactly where you want them
- Extremely tough, yet lightweight
- Available rail sizes, 2", 3", 4", 6" and 12"

Comfortably place rails at 45° angles for a more natural placement of accessories.



ATI AR-15 Carbine Two Piece Forend Combo Rail Package

Package Includes:

- Hard Coat T6 Aluminum Carbine Forend
- Two 2", Two 4", and Two 6" Rails
- Delta Ring

#118-ATI-A5101210

ATI AR-15 Carbine Free Float Forend Combo Rail Package

Package Includes:

- Hard Coat T6 Aluminum Carbine Forend
- Two 2", Two 4", and Two 6" Rails
- Barrel Nut & Jam Nut

118-ATI-A5101270

ATI AR-15 Rifle Length Free Float Forend Combo Rail Package

Package Includes:

- Hard Coat T6 Aluminum Rifle Length Forend
- Two 12" and Six 4" Rails
- Barrel Nut & Jam Nut

#118-ATI-A5101400



Weaver Tactical Two Piece Rail Forend

Upgrade your AR-15 rifle or carbine with the new 2-piece Quad Rail Forend from Weaver.

Engineered to provide superior weapon control and sling movement, this new forend features full length Picatinny quad rails for the ultimate in accessories placement and a rugged 2-piece design that interlocks for maximum strength.

Made in the USA.

#105-BK-71QF00-BK 2-pc Quad Rail Forend—AR-15 Rifle

#105-BK-71QF01-BK 2-pc Quad Rail Forend—AR-15 Carbine



Magpul Full Length XT Panel Rail

Provides a semi-rubbery grip surface for improve weapon control.

#MAG-012-BLK Black
#MAG-012-DKEAR Dark Earth
#MAG-012-ODGRN OD Green

Magpul Ladder Rail Protector

Provides a very low profile grip. Protects the operator from sharp rail edges. Protects unmounted rail areas from damage.

#MAG-013-BLK Black
#MAG-013-DKEAR Dark Earth
#MAG-013-ODGRN OD Green

Magpul XTM Rail Panel

The new low-profile XTM Rail Panels are a two-piece design that attach anywhere on the rail without having to remove previously-mounted accessories. The combination of design and material used in the XTM Panels ensures they will remain securely in place under all operating conditions, but may be easily removed using the tips of two rounds when necessary.

#MAG-410-BLK Black
#MAG-410-DKEAR Dark Earth
#MAG-410-FOLGR Foliage Green
#MAG-410-ODGRN Olive Drab



ERGO Rail Hand Stops

Black, Pack of 2
#119-EG-4202-BK

ERGO SURESTOP Tactical Rail Hand Stop

Black
#119-EG-4201-SS



ERGO Diamond Plate Pattern Rail Cover

Ergo ribbed redi-cover rail cover clips to picatinny rail for improved weapon control. Prevents damage to gear, such as rappelling ropes, that may be abraded by uncovered rail sections. Covers 15 slots or easily cuts into (3) five slot or (1) five slot and (1) ten slot.

#119-EG-4368-3PK-BLK Black
#119-EG-4368-3PK-DE Dark Earth
#119-EG-4368-3PK-OD OD Green

ERGO LowPro Rail Cover, package of 3

- Provides a very low profile grip
- Protects the operator from sharp rail edges and protects unmounted rail areas from damage
- Comes in a pack of 3
- Made in the USA

#119-EG-4373-3PK-BLK Black
#119-EG-4373-3PK-DE Dark Earth
#119-EG-4373-3PK-OD OD Green



ITT Enidine AR Restor Hydraulic Recoil Buffer

Enidine AR-Restor Hydraulic Recoil Buffer.

This is the best buffer on the market today! Reduce felt recoil, improve accuracy, reduce fire rate, suppress bolt bounce, and protect your valuable optics with this simple drop-in replacement. Enidine hydraulic recoil buffers have been employed in military applications to reduce recoil, improve accuracy and increase reliability. Examples include the soft mount for the M2 machine gun and the M249 SAW. Tests have shown the buffer to produce a reduced rate of fire by approximately 200 rounds per minute. The Enidine AR-Restor Hydraulic Recoil Buffer comes with a full 1 year warranty.

#ITT-SP22461ENI AR-15 Restor Hydraulic Recoil Buffer Carbine
#ITT-SP22453ENI AR-15 Restor Hydraulic Recoil Buffer Full Stock
#ITT-SP229392ENI AR-10 Carbine Restor Hydraulic Recoil Buffer
#ITT-SP224552ENI AR-10 Carbine Short Restor Hydraulic Recoil Buffer
#ITT-SP23357ENI AR-10 Full Stock Restor Hydraulic Recoil Buffer





Magpul MOE Hand Guard

The Magpul MOE™ Hand Guard for M16/AR15 rifles with carbine-length gas systems combines the light weight of a standard hand guard with modular flexibility. Slots at the two, six, and ten o'clock positions allow for optional mounting of Picatinny rail sections for tactical lights and other accessories. Reinforced, heat-resistant polymer construction provides operational durability without the weight and expense of an aluminum rail hand guard.

Carbine Length	Mid Length	Rifle Length
#MAG-405-BLK Black	#MAG-418-BLK Black	#MAG-419-BLK Black
#MAG-405-DKEAR Dark Earth	#MAG-418-DKEAR Dark Earth	#MAG-419-DKEAR Dark Earth
#MAG-405-FOLGR Foliage Gr	#MAG-418-FOLGR Foliage Gr	#MAG-419-FOLGR Foliage Gr
#MAG-405-ODGRN Olive Drab	#MAG-418-ODGRN Olive Drab	#MAG-419-ODGRN Olive Drab

Magpul ACS Carbine Stock, Mil-Spec Version

drop-in replacement butt-stock for carbines using mil-spec receiver extension tubes. A streamlined, anti-snag profile shields the release latch to prevent accidental activation and the extra-power lock mechanism uses a premium chrome-silicon spring to avert auto-collapse failure by resisting spring relaxation.



Magpul MOE Polymer Rail Section

Designed for use with MOE Hand Guards and most standard plastic hand guards, the MOE Polymer Rail Sections allow the attachment of various 1913 Picatinny spec rail-mounted accessories such as lights, vertical grips, etc.

#MAG-406-BLK Size L2 (5 Slots), max overall length of 2.5"
#MAG-407-BLK Size L3 (7 Slots), max overall length of 3.25"
#MAG-408-BLK Size L4 (9 Slots), max overall length of 4.00"
#MAG-409-BLK Size L5 (11 Slots), max overall length of 5.00"



Ergo Grip Hand Guard Rail Section

This polymer Mil-Spec M1913 Picatinny rail section (10 slots) can be attached to the MOE Hand Guard

#MAG-FAL002-BLK



Magpul MOE Illumination Kit

The Magpul MOE Illumination Kit includes everything needed to mount a 1913 Picatinny rail compatible weapon light to a Magpul MOE Hand Guard. The four-piece kit includes a short rail section, cantilever rail mount, two Surefire optimized pressure switch pad mounts (both old and new styles), and all mounting hardware.

#MAG-402-BLK



Magpul UBR Stock

The Magpul UBR™ (Utility/Battle Rifle), is a fully-featured, adjustable butt-stock for the AR15 / M16. Unlike typical collapsing stocks, this modular design offers the stability of a fixed stock with consistent cheek weld in any position. Seven-position length-of-pull (LOP) adjustment is quickly executed with gross motor movement while the integral preset system allows direct access to a preferred position. A robust lock mechanism and multi-shell construction increase durability under severe impact conditions experienced during malfunction clearing and accommodates large-bore AR calibers.

#MAG-330-BLK	Black
#MAG-330-DKEAR	Dark Earth
#MAG-330-FOLGR	Foliage Green
#MAG-330-ODGRN	Olive Drab

IWC Accessories for the Magpul MOE Handguard

- 1 IWC MOUNT-N-SLOT Bipod Mount-V2
#130-IWC-BBF0
- 2 IWC Swivel Type Sling MOUNT-N-SLOT
#130-IWC-SSTF0
- 3 IWC Snap Hook MOUNT-N-SLOT
#130-IWC-SSHFO
- 4 IWC MOUNT-N-SLOT Rotation Limited Quick Detach Sling
#130-IWC-SQDRLF0
- IWC MOUNT-N-SLOT Rotation 360 Quick Detach Sling
#130-IWC-SQDRLF0





Magpul CTR Carbine Stock

The Magpul CTR™ (Compact / Type Restricted) is a drop-in replacement Butt-stock for carbines using commercial receiver extension tubes. Designed for light, fast action the streamlined A-frame profile avoids snagging and shields the release latch to prevent accidental activation.

Commercial Carbine Stock

- #MAG-311-BLK Black
- #MAG-311-DKEAR Dark Earth
- #MAG-311-FOLGR Foliage Green
- #MAG-311-ODGRN OD Green

Mil-Spec Carbine Stock

- #MAG-310-BLK Black
- #MAG-310-DKEAR Dark Earth
- #MAG-310-FOLGR Foliage Green

Magpul CTR M4 Carbine Collapsible Butt-stock

Magpul Original Equipment (MOE™) is a line of firearm accessories designed to provide a high-quality, economical alternative to standard weapon parts. The MOE™ line distinguishes itself with a simplified feature set, but maintains Magpul engineering and material quality.

- #MAG-400-BLK Black, Mil-Spec Carbine Stock
- #MAG-401-BLK Black Commercial Carbine Stock



Magpul CTR Rubber Butt-Pad

The Rubber Butt-Pad, 0.30" comes standard with the CTR and MOE Mil-spec stocks as well as the UBR stock. May not be compatible with CTR/MOE Commercial stocks due to Receiver Extension clearance issues.

- #MAG-315-BLK Rubber Butt-Pad, 0.30"
- #MAG-316-BLK Rubber Butt-Pad, 0.55"
- #MAG-317-BLK Rubber Butt-Pad, 0.70"



Magpul PRS Stock

The Magpul PRS™ (Precision Rifle / Sniper) is a drop-in, precision-adjustable butt-stock for rifles with A1 / A2 fixed stocks. Designed to offer the fine-tuned, customized feel of a precision target stock, the PRS™ is adjustable for both cheek riser height and length-of-pull without sacrificing the durability necessary to withstand the operational environment. Compared to the A2 stock, the PRS™ can shorten the LOP by 0.25" or extend it by 0.75".



- PRS AR15/M16
- #MAG-307-BLK Black
- #MAG-307-DKEAR Dark Earth
- #MAG-307-FOLGR Foliage Green
- #MAG-307-ODGRN OD Green

Precision rifle stock, GEN II for AR10

- #MAG-308-BLK Black
- #MAG-308-DKEAR Dark Earth
- #MAG-308-FOLGR Foliage Green
- #MAG-308-ODGRN OD Green

ERGO F93 PRO 8 position collapsible AR-15 Stock

The ERGO F93 Pro Stock features a fixed cheek piece for a constant and repeatable cheek weld in any of the eight available stock positions. Once the butt is locked into position, the F93 is as rigid as a fixed stock. Included is an overmolded carbine length buffer tube, a standard castle nut and an ambidextrous sling plate. At 8" from receiver to butt plate when completely collapsed and 12" when fully extended, this stock gives the shooter plenty of room for adjustment. This assembly weighs 1.3 pounds and is made in the USA.

- #119-EG-4925
- #119-EG-4980



ERGO F93 PRO Stock Strike Plate (not shown)



Weaver Ergonomic Grip for AR-15/M16

Get maximum weapon control with the new Ergonomic Grip from Weaver. Designed with an integral upper extension that helps support the web of your hand and slight finger grooves, this new grip prevents hand fatigue during long hours of weapon handling. Ideal for use with or without gloves. The aggressive textured grip surface minimizes slippage and is virtually impervious to oils and solvents used to clean and lubricate firearms.

- #105-71EG00-BK Black
- #105-71EG00-OD Olive Drab
- #105-71EG00-DK Dark Earth

Duostock Tactical M4/CAR15 Stock

The patented Tactical Duostock is a modification to the stock of a rifle or shotgun for the specific use in Close Quarters Battle (CQB). It consists of an upper and lower surface for the absorption of recoil. The upper surface is the same as any other long weapon. The lower surface is specially angled to ride on the upper chest with the use of body armor. The bottom of the stock is rounded and allows smooth targeting of the weapon. This makes for a more stable, consistent shooting platform with the sights and barrel close to the line of sight. This results in increased comfort, speed, and accuracy in any shooting position.

- #DSD-TDM4-MS-BL MIL-SPEC Black
- #DSD-TDM4-MS-T MIL-SPEC Tan
- #DSD-TDM4-U-BL Universal Black
- #DSD-TDM4-U-T Universal Tan

Duostock Tactical with Complete Assembly

All that is needed to convert a fixed stock AR-15/M-16 to a collapsible stock. Besides the Tactical Duostock, the "Complete Assembly" includes an American-made Buffer Tube, Buffer, Spring, End Plate, and Locking Ring.

- #DSD-TDM4-MS-ASBLY



Magpul MOE Grip

The Magpul Original Equipment (MOE) AR-15 pistol grip improves comfort for better weapon handling and control. The new Magpul Original Equipment (MOE) pistol grip gives the shooter a more comfortable, secure grasp than the standard, A2-style grip for better trigger control and recoil management with less fatigue.

- #MAG-415--BLK Black
- #MAG-415-DKEAR Dark Earth
- #MAG-415-FOLGR Foliage Green
- #MAG-415-ODGRN OD Green



TAPCO AR-15 Accessories Shown in Dark Earth

Magpul MIAD AR-15 Grip Kit

The patent-pending MIAD (Mission ADapt-able) Grip is a drop-in replacement for the standard AR15/M16/M4 pistol grip, designed to improve weapon ergonomics. Interchangeable front and rear straps, as well as a range of storage core options allow the end user to adjust the grip for hand size as well as dynamic mission requirements. All mounting hardware is included.

- #MAG-050-BLK Black
- #MAG-050-DKEAR Dark Earth
- #MAG-050-FOLGR Foliage Green
- #MAG-050-ODGRN OD Green



Magpul MIAD AR10/SR25 Grip Wedge

The MIAD Grip Wedge is designed to supplement the Magpul MIAD grip system for AR10/SR25 7.62 NATO type applications. Flexible thermoplastic elastomer construction provides the proper rear take-down pin detent spring support and conforms to the larger receiver geometry of these weapons for a streamlined appearance.

- #MAG-065-BLK



ERGO Grip Spacer for Large Frame AR

Use to fill rear upper void on large frame AR type weapons

- #119-EG-4012-BK



Magpul MIAD Grip Core for AA/AAA Batteries

Internal core unit for either the MIAD or MOE grips designed to hold two (2) AA type batteries in a self contained waterproof unit.

- #MAG-056-BLK Black
- #MAG-056-DKEAR Dark Earth
- #MAG-056-FOLGR Foliage Green
- #MAG-056-ODGRN OD Green



Magpul MIAD Grip Core for 123

Internal core unit for either the MIAD or MOE grips designed to hold two (2) 123 type batteries in a self contained waterproof unit. Rubber cap is captured to the unit and can be opened with a push of the thumb.

- #MAG-055-BLK Black
- #MAG-055-DKEAR Dark Earth
- #MAG-055-FOLGR Foliage Green
- #MAG-055-ODGRN OD Green



Magpul Enhanced Trigger Guard

The Enhanced Trigger Guard is an aluminum drop in replacement for the M16/AR15 weapons platform. It features a shallow "V" shape for better use of gloves in tactical shooting or cold weather operations. The Enhanced Trigger Guard is non-folding, has rounded edges, and fills the annoying "gap" at the rear of the standard trigger guard.

- #MAG-015-MIAD Black AR15, MIAD



Magpul MOE Trigger Guard, Polymer

The MOE™ Trigger Guard is an enhanced polymer drop in replacement for the M16/AR15 weapons platform. It features a shallow "V" shape for better use of gloves in tactical shooting or cold weather operations. The MOE™ Trigger Guard is non-folding, has rounded edges, and fills the annoying "gap" at the rear of the standard trigger guard.

- #MAG-417-BLK Black
- #MAG-417-DKEAR Dark Earth
- #MAG-417-FOLGR Foliage Green
- #MAG-417-ODGRN Olive Drab



TAPCO AR-15 Collapsible Stock

- Perfect for military and police applications; six (6) position stock easily adjusts to body armor
- Collapsed length: 8.25" Extended length: 10.50"

- Manufactured out of military grade composite
- Ergonomically designed for better comfort
- #STT-STK09161-BLK Black w/ tube, buffer and spring
- #STT-STK09161-DE Dark Earth w/ tube, buffer and spring
- #STT-STK09161-OD Olive Drab w/ tube, buffer and spring
- #STT-STK0916-BLK Black, Body Only
- #STT-STK0916-DE Dark Earth, Body Only
- #STT-STK0916-OD Olive Drab, Body Only

TAPCO AR-15 SAW Stlye Pistol Grip

Inspired by the M249 Squad Automatic Weapon, the AR SAW grip features a more ergonomic angle and increased width for greater comfort and control. Inside the grip housing is a useful storage compartment. Constructed of military-grade composite for years of use.

- #STT-STK09201-BLK Black
- #STT-STK09201-DE Dark Earth
- #STT-STK09201-OD Olive Drab



TAPCO T6 Rubber Buttpad

Easily installed on any T6 or M4 style collapsible stock, this rubber buttpad reduces the weapon's felt recoil while positioning the stock to the shoulder for better controllability.

- #STT-STK90161 Black

TAPCO Intrafuse AR Handguard

Designed to address the needs of every shooter – both civilian and tactical professionals. Constructed of high-strength composite, this handguard is extremely durable and offers a 50% weight reduction over comparable aluminum systems. The Picatinny rails located at 3, 6, 9, and 12 o'clock enables the shooter to mount vertical grips, flashlights, and aiming lasers to their weapon.

- #STT-STK09301-BLK Black
- #STT-STK09301-DE Dark Earth
- #STT-STK09301-OD Olive Drab



ERGO AR-15 A2 Grip, Black

A standard A2 grip with hinged trap door for stowing batteries, spare parts, cleaning gear, ect. The Trap door is opened by pushing a 5.56mm cartridge point into the catch hole at the rear of the grip.

- #119-EG-4095-BK



ERGO AR15/M16 Grip Kit, SUREGRIP

Over molded rubber surface resembling the consistency of a pencil eraser and offers the user a grip with a little give

- #119-EG-4000-BK AR-15 Right Hand, Black
- #119-EG-4005-BK AR-15 Ambidextrous, Black
- #119-EG-4000-LF-BK AR-10 (large Frame) Right Hand, Black
- #119-EG-4005-LF-BK AR-10 (large Frame) Ambidextrous, Black



ERGO AR15 Tactical Deluxe Grip, SUREGRIP

A more robust design than other grips, this design has a generous swell in the midsection that fits into the small of the palm. This grip is best suited for medium to large sized hands. The non-skid finish allows positive control of your weapon under all climate conditions and provides traction under a variety of shooting positions.

- #119-EG-4045 AR-15 Ambidextrous, Black
- #119-EG-4055 AR-15 Ambidextrous/Palm Shelf, Black



ERGO A2 Pistol Grip Plug

- #119-EG-4933-A2-BK Black



ERGO Grip AR-15 Gapper

- #119-EG-4085



Sightlink, Fiber Optic Sights



Big dot for speed or instantly flip the blade

And... Small dot for accuracy!

The first totally adjustable front sight linking the robust accuracy of Mil-Spec AR-15/M16 sighting systems with the advantages of fiber-optic technology.

- Spring loaded for rock-solid stability.
- Custom detent plunger locks blade in place.
- 5/8" MOA height adjustment per click. (Mil-Spec is 1.25 MOA per click).
- And the patented* "Two Sights In One" system.
- Instantly change from big dot to small dot without changing height adjustment.



- #FOS-070-MS1 .070 Mil-Spec
- #FOS-060-MA4 .060 Match Sight
- #FOS-050-UMB .050 Ultra Match

ERGO AR Lower Spring Replacement Kit

Nine piece kit includes: Bolt Catch Spring, Disconnecter Spring, Buffer Retainer Spring, Trigger Spring, Magazine Catch Spring, Hammer Spring, Selector Spring, two Detent Springs.

#119-EG-4612



ERGO AR Upper Spring Replacement Kit

Five piece kit includes: Ejector Spring, Forward Assist Spring, Port Cover Spring, Extractor Spring, Extractor Spring Buffer

#119-EG-4611

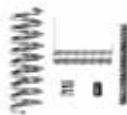

Samson Quick Flip PVS-14 & Magnifier Interlocking Mount

Latest PVS-14 mount converts to a magnifier mount with the push of a button. Works for both Aimpoint and Eotech magnifiers. The Quick Flip feature is functional for all three devices. PVS mount price includes the price for either the Aimpoint or Eotech magnifier mount.

- #SMC-QF-PVS14-AIM PVS-14 & Aimpoint 3X
- #SMC-QF-PVS14-EO PVS-14 & Eotech 3X



PRI-ITT-PVS14 Quick Detachable Mount

For Litton 914 Pocket Scope (Adjustable Height)

#PRI-PVS-14A



PVS-18 Quick Detachable Mount

Adjustable Height, Pocket Scope

#PRI-PVS-18A



#PRI-PVS-18A (Shown with Litton 983 Sight)

PVS-17 Mount

Quick Detachable, High or Low Positions

#PRI-PVS-17A



A.R.M.S. #20

Night Vision Throw Lever Mount/ AN-PVS-4

#ARMS-20



A.R.M.S. #11 Aquila Adapter

Attaches to A.R.M.S. #19

#ARMS-11



Universal Sight Adjustment Tool AR-15/M16

Installation tool for all M16 /AR-15 Front Sights.

Included with Sightlink products.

Also sold separately.

#FOT-FST-001 USAT



Signature Series T-50...

The Ultimate Sight for

Ultimate Accuracy!

Endorsed by Ted Puente



Used to win USPSA

3-Gun Limited Division Nationals in both 2006 and 2007 as well as the Limited Pistol Nationals in 2009 using a sightlink series pistol sight (pg. 42)

(Sightlink T-50 is as thin as a dime)

Ted Puente



All Fiber Optic Products from MSP use industry standard fiber optic rods intended to be changed by the user in seconds!

Replacement Fiber Optics...

Sold by the foot.

MSP Fiber Optic Rods

- #FOR-200-RED .080 Red (2mm)
- #FOR-200-GRE .080 Green (2mm)

MSP TRI-LINK and others

- #FOR-060-RED .060 Red (1.5mm)
- #FOR-060-GRE .060 Green (1.5mm)
- #FOR-060-AMB .060 Amber (1.5mm)

MSP SIGHT-LINK and others

- #FOR-040-RED .040 Red (1mm)
- #FOR-040-GRE .040 Green (1mm)
- #FOR-040-AMB .040 Amber (1mm)

- #FOR-030-RED .030 Red (.75mm)
- #FOR-030-GRE .030 Green (.75mm)
- #FOR-030-AMB .030 Amber (.75mm)

- #FOR-020-RED .020 Red (.5mm)
- #FOR-020-GRE .020 Green (.5mm)
- #FOR-020-AMB .020 Amber (.5mm)

A.R.M.S. #12

Engineered to provide the optimal combination of the A.R.M.S. repeat zero Q.D. Throw Levers with the New **Leupold CQ/T Scope**. Multi-fastened CQ/T optic.

#ARMS-12



For greater eye relief!

A-952 Spacer

Spacer for Raptor 6x

Greater Eye Relief for Night Vision or other special needs using A.R.M.S. bases.

#NLR-RSA-952



A.R.M.S. #71L series, Front and Rear Sights

- Designed to allow attachment to all Universal Dovetail 1913 and Weaver style Rails.
- Both are made from durable, metal-reinforced polymer and are a good option when seeking a quality sight.
- Both are .610" when in the folded position, from the top of the receiver.

The #71L-F (front sight) is rail mounted with a quick deploy latch and adjustable for elevation while the #71L-R (rear sight) features the same metal dual apertures, utilized in the A.R.M.S. #40L under contract with Crane Naval Special Warfare Center, for both CQB and long range shooting applications.

- #ARMS-71L-F-R Front and Rear Sights Set
- #ARMS-71L-R Rear Sight
- #ARMS-71L-F Front Sight



A.R.M.S. #40 - ORIGINAL

The unique design of the spring loaded rear sight ensures constant in battery action and repeat zero. The sight is held in the locked down position by a quick release lever, that prevents the sight from being accidentally engaged, but is as fast as a trigger to release even with arctic mittens. Has military horizon line notch, 500-600 meter sight. Windage adjustments .75 MOA

#ARMS-40

A.R.M.S. #40A2

Flip Up Rear Sight 250 to 300 meters
#ARMS-40A



A.R.M.S. #40L

The #40L has all the features of our excellent 40A2 sight, but has a lower profile, allowing more clearance for mounting optics to your flat-top receiver and allows lower mounting, miniaturized windage knob with .75 M adjustment and a very new and unique dual aperture.

#ARMS-40L



A.R.M.S. #40L-SP

The #40L-SP is identical to the #40L but it utilizes the same plane aperture system. Choose between large and small apertures without worrying about them being zeroed to different ranges.

#ARMS-40L-SP

A.R.M.S. #40L-P

"P" Means Precision. .50 MOA = minute of angle, means at 100 meters, each click of the windage knob moves the apertures .50 = 1/2 inch, which means point of impact .50 left or right of the previous click setting.

#ARMS-40L-P



A.R.M.S. #41B

Front folding sight solves the problem of trying to fold the well known triangle shape of the conventional non folding front sights. Barrel mounted in place. Utilizes a rugged spring loaded angled support system to eliminate getting caught up in brush and other combat hazards. Also uses the standard front sight post. #ARMS-41B

A.R.M.S. #41B-L

Same as the #41B with bayonet lug.
#ARMS-41B-L

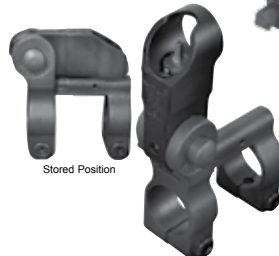

PRI Flip Up Sight for Barrels Cross Bolt Style

- #PRI-FUP-01S .750" Barrels
- #PRI-FUP-02S .625" Barrels

Magpul MBUS Front & Rear Sight - GEN I

- The MBUS (Magpul Back-Up Sight) is a low-cost, color injection molded, folding back-up sight.
- The MBUS Rear Sight dual aperture MBUS Rear Sight is adjustable for windage and fits all mil-spec 1913 Picatinny rail equipped weapons
- The MBUS Front Sight is adjustable for elevation and fits all mil-spec 1913 Picatinny rail equipped weapons, but is specifically tailored to the AR15/M16/M4 platform.



Magpul MBUS Front Sights

- #MAG-246-BLK Front Sight, Black
- #MAG-246-DKEAR Front Sight Dark Earth
- #MAG-246-FOLGR Front Sight Foliage Green
- #MAG-246-ODGRN Front Sight Olive Drab

Magpul MBUS Rear Sights

- #MAG-330-BLK Rear Sight, Black
- #MAG-245-DKEAR Rear Sight, Dark Earth
- #MAG-245-FOLGR Rear Sight, Foliage Green
- #MAG-245-ODGRN Rear Sight, Olive Drab



Samson Flip Up Sight

- All sights are made from 6061 aluminum mil-spec hardcoat anodized for durability.
- All of the sights lock in both deployed and folded positions.
- The spring mechanism is quite durable and is completely concealed.

Samson QF-FRS-A2 Flip Up Rear Sight, Dual Aperture A2

- The dual aperture rear BUIS has a conventional large and small aperture.
- The sight deploys with the large aperture.

#SMC-QF-FRS-D



Samson FFS (Folding Front Sight)

Available in HK config and A2 config & rail height and railed gas block heights

- #SMC-QFS-FFS-HK HK config rail height
- #SMC-QFS-FFS-A2 A2 config rail height
- #SMC-QF-FFS-EXT-HK HK config rail gas block height
- #SMC-QF-FFS-EXT-A2 A2 config rail gas block height



Samson Quick Flip™ FFS-B

- Folding Front Sight (Barrel Mount)
- Available in HK config and A2 config.

- #SMC-QF-FFS-B-HK HK config
- #SMC-QF-FFS-B-A2 A2 config



Samson Quick Flip FFS SIG

- Folding Front Sight for the Sig 556 Sight
- Available in HK config and A2 config.

- #SMC-QFS-SIG-HK HK config
- #SMC-QFS-SIG-A2 A2 config

PRI Flip Up Rear Sight

Designed to work on the same plane aperture system that allows the operator to choose between two different settings without losing zero. The low profile sight will allow the use of optics and the top rails. The sight folds up into a locked and secured position with windage adjustment.

#PRI-FUP-RSO



PRI Rail Mounted Flip Up Sight

The rail mounted sight works on any rail that is mounted at the same levels as the receivers rail.

#PRI-FUP-RMF



Adams Arms Drop-In Piston Conversion Kits

There are those that believe the current AR15/M-16 Platform should be replaced with newer rifles costing much more than the current system in place. What these companies and/or designers fail to recognize is that there are millions of these rifles already in service around the world, whether owned by Private Citizens, Military, or Law Enforcement.

The Adams Arms Gas Piston System is an end user installed after-market product for Mil-Spec ARs. It will fit on any AR barrel with a .750" or 3/4" diameter at the shoulder where the front sight base sits.

Adams Arms Drop-In Piston Conversion Kits - AR Pistol (PDW) with 4" Free Float Quad Rail

- Contains our one piece bolt carrier and a four inch 4 railed forend.
- Fits 7.5" to 8.5" barrels that has an existing pistol gas system.

#116-AA-PPD-D-ADA

Adams Arms Drop-In Piston Conversion Kits - Carbine

- Contains our 1 piece bolt carrier, handguards and handguard cap. The Adams Arms Gas Piston System is an end user installed after-market product for Mil-Spec ARs.
- Fits 10.5" to 16" barrels that has an existing midlength gas system.

#116-AA-CPS-D-ADA

Adams Arms Drop-In Piston Conversion Kits - Mid Length

- Contains our 1 piece bolt carrier, handguards and handguard cap. The Adams Arms Gas Piston System is an end user installed after-market product for Mil-Spec ARs.
- Fits 16" to 18" barrels that has an existing midlength gas system.

#118-AA-MPS-D-ADA



Adams Arms Drop-In Piston Conversion Kits - Rifle Length

- Contains our 1 piece bolt carrier, handguards and handguard cap. The Adams Arms Gas Piston System is an end user installed after-market product for Mil-Spec ARs.
- Fits 18" to 24" barrels that has an existing midlength gas system.

#118-AA-MPS-D-ADA

PRI MSTN Muzzle Brake for 5.56mm

The MSTN Quiet Control Brake / Compensator has a system of ports to reduce the felt recoil and the climb of the muzzle and to the right. The QCB has been cut from solid stainless steel bar stock for greater resistance to heat and burnout.

- #PRI-MST-NO1 Silver
- #PRI-MST-NO2 Black



PRI Low Profile Gas Block

PRI Steel constructed gas block for the AR15/M16

- #PRI-NGB-SO1 .750 diameter - Black
- #PRI-NGB-SS2 .750 diameter - Stainless Steel
- #PRI-05-87501 .875 diameter - Black
- #PRI-05-93601 .936 diameter - Black

PRI Latches

Oversized latch handle that is quick & easy to cycle.

- 1 #PRI-BLO-001 Big Latch (Flat Style)
- 2 #PRI-BLO-002 Big Latch (Military Style)
- 3 #PRI-BLO-003 Combat Latch



PRI Gas Buster Charging Handle

M84 Gas Buster AR15-M16-M4 Charging Handle. Featuring The Big Latch or Combat Latch increases safety by inhibiting harmful blowback gas and oil particles from striking shooter's face and gasses.

- #PRI-M69-GB2 AR-15/M-16/M-4 w/ Big Latch
- #PRI-M69-GB4 AR-15/M-16/M-4 w/ Combat Latch
- #PRI-M69-GB3 SR25 w/ Big Latch
- #PRI-M69-GB5 9mm w/ Combat Latch
- #PRI-M69-GB6 9mm w/ Big Latch



PRI Gas Block Top Picatinny Rail

- .750 diameter barrel.
- 2 1/2" top rail same plain as the receiver.
- Hard Coat Aluminum constructed

#PRI-05-07504



Samson Low Profile Gas Block

- Stainless Steel
- Four 10-32 set screws, two tangential clamping for added clamping.
- Extended front to cover standard FSB scar

#SMC-GAS-BLOCK



ArmaDynamics ACLM, Ambidextrous AR-15 Charging Handle for 5.56

The ARMADYNAMICS™ ACLM™ (Advanced Combat Latching Mechanism) is the most ergonomic, user friendly, and advanced charging handle ever designed for the AR-15/M-16/M-4 family of weapons. It is the only truly ambidextrous charging handle available. Now, tactical utility and combat effectiveness in charging of the weapon under all conditions can be maintained without need of compromise or loss of tactile efficiency for all operators, right or left handed, under all conditions.

FEATURING:

- Patent-pending, completely intuitive, straight pull operation, no separate latch activation required
- Unique fully ambidextrous grasping handle
- Aggressive tactile grasping surfaces function in all situations
- Manual override button equipped
- Proprietary TEFLON inserts assure reliable operation in all environments
- Manufactured from aircraft grade aluminum 7075-T6 alloy, and Ordnance grade 4100-Series steels
- Finished to MIL-A-8625 Type III, Class 2 hard coat & MIL-DTL-13924D military specifications
- Available Finishes: MIL SPEC Flat Black
- Model A081 for 5.56/6.8/9mm AR-15/M-16/M4 style and related weapons

#ACLM-ACH-001 Model A081

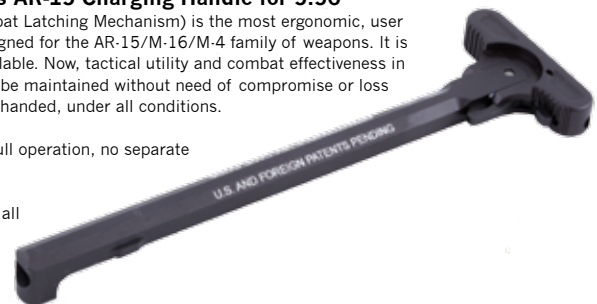

Magpul Enhanced Self Leveling Follower 5.56 NATO

The Magpul Gen III Self Leveling Follower is a drop in replacement for the current issue USGI 30 round magazine follower.
#MAG-010-FOLGR Foliage Green



Magpul PMAG Ranger Plate, 3 Pack

A floorplate replacement for 20 and 30 round PMAGs that incorporates an integral loop similar to the original USGI Magpul Ranger.
#MAG-212-BLK 3 pack- Black



Magpul 5.56 NATO Standard 3 Pack

When installed on the base of a rifle magazine, the Magpul provides unsurpassed speed and controllability during high stress, tactical magazine changes.
#MAG-001-BLK Black



Magpul 5.56 NATO Standard 3 Pack

When installed on the base of a rifle magazine, the Magpul provides unsurpassed speed and controllability during high stress, tactical magazine changes.
#MAG-001-BLK Black

Magrip Products Dual Mag Holder

For use with .223/5.56 mm rifles
#MAG-GRIP-001
#MAG-GRIP-002 Magpul P-Mag



Buffer Technology Dual Mag Cinches

The MAG CINCH™ System (patent pending) allows anyone with a need for high ammo capacity to carry two magazines with their rifle.

#BUFT-MC1 MP5 and SMG Mag cinch
#BUFT-MC2 AR 15 Mag cinch for 30 round mags
#BUFT-MC3 AK Mag cinch
#BUFT-MC8 AR 15 Mag cinch for 20 round mags



TAPCO AR-15 Cleaning Stars

The AR15/M16 weapon requires clean chamber lugs to function properly. Attached to your standard bore brush, they quickly clean this often neglected area.
#STT-CLN0920 20 PACK



Samson Field Survivor

Imagine having every tool you need to get your AR back in service, right from your pistol grip. The Samson Field Survivor is a multi-tool system that has a patent-pending mechanism which secures inside the pistol grip.

#SMC-FST-A2 For Standard AR Pistol Grips
#SMC-FST-MAG For Magpul Grips



The Samson Field survivor contains:

- Broken shell extractor
- Wire brush for bore cleaning
- Ampule for oil for one field lube
- Cable to pull the brush through the bore
- Carbon scrapping tool
- Flat blade screwdriver
- Feed lip adjustment tool
- Gas key cleaning tool
- Cotter pin hook
- Strike Plate
- Front sight adjustment tool
- Magazine feed lip gauge

No-Mar Delta Wrench

Model 2130 (Handguard Removal Tool) Provides leverage needed to compress the spring inside the delta ring.

#LLR-GST-004



PRI Barrel Nut Wrench

This wrench allows the shooter to put the exact amount of pressure needed on the barrel nut while attaching the barrel to the receiver.

#PRI-05-0082 For the AR-15
#PRI-03-0085 For the Armalite AR10
#PRI-03-0086 For the DPMS / KAC 308



TAPCO Enhanced AR-15/M4 Stock Wrench

Precision machined from heat treated steel, our multifunction tool is a necessity for any AR enthusiast. This tool includes a Mil-Spec castle nut wrench, a standard length receiver extension removal wrench, and an A1/A2 Flash Suppressor wrench. Offering an improved grip, each tool has a rubberized grip for both safety and comfort. Every tool is coated in manganese phosphate for reduced visibility and corrosion resistance. Made in the USA and features a lifetime warranty.
#STT-TOOL0904

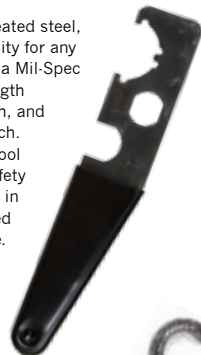

NcStar AR-15 Armorer Wrench

• Constructed of Steel with Durable Powder Coat Finish
 • Compatible with Most M16, M4, and ARs
#111-NCS-TARW



NcStar AR-15 Combo Tool

• Handy and Compact Multi-tool
 • Stainless Steel - Includes Bore Cleaning Cable and Carry Case
 • Compatible with Most M16, M4, and ARs

#111-NCS-TAR



PRI AR-15 or AR-10 Upper Receiver Takedown Pin Vise Block

This block holds an AR-15 or AR-10 upper receiver by the lugs. The block can then be clamped into a vise allowing numerous tasks to be accomplished.

#PRI-WRB-UBR



Hammerhead AR-15 Rifle Tool "Bite hard, Holds hard"

Features:
 • 3/4" Flash hider wrench: (do not apply more than 10ft lb. of torque. Do not over torque)
 • Patent Pending, Four-Point Castle Nut Wrench: (remove collapsible stock, slide down over buffer tube. Stabilize wrench by firmly grasping "hammer head". Hand tighten or torque to recommended spec.)
 • 3/8" torque drive socket: (Always start torque wrench perpendicular to hammerhead tool, tighten in small increments returning to start position between turns.)
 • 5/8" A-2 style stock extension tube wrench
 • Receiver take-down and pivot pin punch
#121-HRT-ST-01





Muzzlelite Bullpup Stocks

The most striking feature of the Muzzlelite Bullpup Stock, when attached to your action, is the overall length of 26-1/2". This allows you to carry the rifle with much greater mobility. Whether your sport is hunting or plinking, the Muzzlelite Bullpup Stock will convert a long rifle into a compact weapon system in just a matter of minutes!

Construction is of fiberglass reinforced plastic and fits standard barrels and heavyweight barrels (with minor modifications).



Overall Lengths of Muzzlelite Stocks:

Ruger 1022	#MZ-1022	Approx. Length: 26.5"
Ruger 1022 Plus	#MZ-1022-plus	Approx. Length: 26.5"
Ruger Mini14	#MZ-14	Approx. Length: 26.5"
Ruger Mini14 Plus	#MZ-14-plus	Approx. Length: 26.5"
Marlin CAMP 9	#MZ-09	Approx. Length: 27"
Marlin 22 (Tubular Fed)*	#MZ-60	Approx. Length: 31"
Marlin 22 (Magazine Fed)*	#MZ-70	Approx. Length: 31"

*(Models Not Shown)



Original Muzzlelite Bullpup

Muzzlelite PLUS with 3 Mil-Spec Rails for mounting lights, lasers and scopes



Muzzlelite Rifle Case

Cushioned zippered bag with Shoulder Straps and Modular MOLLE straps to attach utility bags. **#SBI-MZ-CC**

Large Utility Pouch

Modular MOLLE straps to attach on gun bag or vest with side and back mounts. **#SBI-90-CC**



BACK OF POUCH TO SIDE OF BAG

Attached to rifle case with MOLLE straps

Muzzlelite Recoil Pads

For Muzzlelite stocks Adds .5" to overall length **#RPL-BLK-007**



Small Utility Pouch

Modular MOLLE straps to attach on gun bag or vest. (MOLLE straps on back, not shown). **#SBI-SB-CC**



ATI Ruger 10/22 Fiberforce Stock

Lightweight Dragunov .22 Design. Use with Open Sights or Scope **#118-ATI-RUG-3000-B**

ATI Ruger 10/22 Strikeforce - Six Position Side Folding Stock

6 Position Collapsible Side Folding Buttstock with Adjustable Cheekrest & Buttpad

- 6 Position Collapsible/Side folding
- Can Be Fired from Folded Position
- One 4" Picatinny Rail
- Four 2" Picatinny Rails
- Removable/Adjustable Cheekrest
- Non-Slip Removable Rubber Buttpad
- 3 Sling Swivel Studs
- 6" Tube Drop Adaptor for use with Iron Sites
- Made in USA
- Lifetime Warranty

#118-ATI-RUG-1022-B

#118-ATI-RUG-1050-B w/ Forend Pistol Grip



TAPCO Intrafuse 10/22 Rifle System

Intrafuse Rifle System for the 10/22 brings military proven technology to everyone's favorite beginner rifle. Easily installed on your rifle, the Intrafuse Rifle System offers an upgraded look with increased ergonomics and capabilities. The six position stock allows the rifle to adjust to any sized shooter for a tailored fit. Concealed beneath a removable cover, the forearm features a Picatinny rail capable of mounting forward grips and bipods. The included top barrel cover is equipped with an integrated rail designed to accept any Picatinny/Weaver style scope rings. Front and rear sling attachment points are included to ease portability.

#STT-STK63160-BLK

Standard Barrel, Black

#STT-STK63160-DE

Standard Barrel, Dark Earth

#STT-STK63160-OD

Standard Barrel, Olive Drab

#STT-STK63161-BLK

.920 Barrel, Black

#STT-STK63161-DE

.920 Barrel, Dark Earth

#STT-STK63161-OD

.920 Barrel, Olive Drab

TAPCO Ruger 10/22 Accessories Shown in Olive Drab



MSP Ruger 10/22 Fiber Optic Front Sight

The only 1022 fiber optic sight using industry standard fiber optic that can be changed by the user in seconds!
#LLR-1022-FOS

NcStar Ruger 10/22 Muzzle Brake

Slides onto Standard 10/22 Barrels and attaches by Set Screw
#111-NCS-AM1022BS Length 2.5" Black
#111-NCS-AM1022SS Length 2.5" Silver
#111-NCS-AM1022BL Length 3.4" Black
#111-NCS-AM1022SL Length 3.4" Silver



Shooters Ridge, Ruger 10/22 Rifle Stock with Thumbhole

- Thumbhole design and high cheek piece for steadiness, accuracy and comfort.
- Soft recoil pad and easy grip forearm insert
- Comes with swivel studs
- Steel pillar insure secure fit and superior repeatability

.920 Diameter Barrels

- #105-STR-40441 Black
- #105-STR-40444 Carbon Fiber
- #105-STR-40443 Wild Web
- #105-STR-40438 Pink; Realtree Hardwood
- #105-STR-40442 Realtree Hardwood
- #105-STR-40551 Black 30 Rnd Mag/Blued
- #105-STR-40552 WildW w/30 Rnd Mag/Blued
- #105-STR-40554 Black w/Blued Barrel
- #105-STR-40555 Wild Web w/Blued Barrel
- #105-STR-40556 Blue; Realtree Hardwood
- #105-STR-40558 White; Mothwing
- #105-STR-40560 Digital Woodland

Factory Tapered Barrels

- #105-STR-40446 Black
- #105-STR-40449 Carbon Fiber
- #105-STR-40448 Wild Web
- #105-STR-40561 Digital Woodland
- #105-STR-40445 Pink Realtree Hardwood
- #105-STR-40437 Realtree Hardwood
- #105-STR-40557 Blue Realtree Hardwood
- #105-STR-40559 White; Mothwing

Shooters Ridge Ruger 10/22 Extended Magazine Release

These magazines are for use with .17HMR, 22 LR and .22 magnum rifles utilizing Ruger's rotary magazine design. The unique double stack design allows for a 25 round magazine that is no longer than most 10 rounders. For models 77, 96, and 10/22.
#105-STR-40418



Ruger 10/22 Base and Rings

One-piece ring and mount puts an end to misaligned scope rings and expensive scope damage. Matches the factory hole spacing; ultra-strong design attaches in seconds with screws provided. Accepts 1" scopes with up to 40mm diameter objective lens, 4" long.
#WC1-022-INS Silver
#WC1-022-INB Black



Ruger 10/22 Base

No drill and tap mount
#WCR-102-22P Black Mil-Spec Picatinny
#WC1-022-BAS Silver, Weaver
#WC1-022-BAB Black, Weaver style



Weaver Ruger 10/22 Tactical Multi-Slot Bases

Tactical Multi Slot Bases are constructed of tough, lightweight aluminum so they can withstand the most powerful recoil. Picatinny style to accept all Weaver Top Mount
#105-WVR-48335 Multi Slot Ruger 10/22

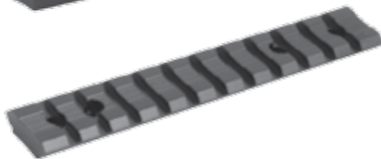

MSP Ruger 10/22 See-Through Scope Base

Unique design permits use of factory iron sights without removing scope base.
#SLR-1022-BSS Short Silver
#SLR-1022-BLS Long Silver
#SLR-1022-BSB Short Black
#SLR-1022-BLB Long Black

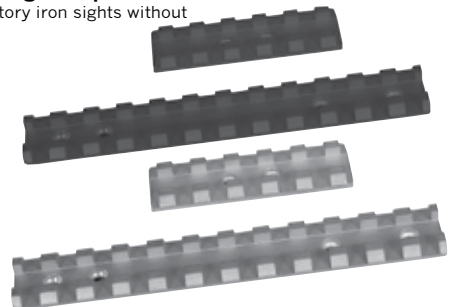

Weigand Ruger 77/22, .22 and .22 Magnum Rifle Scope Mount

Finally a no drill and tap Weaver style scope mount. This scope mount requires no drilling or tapping of your receiver. Handsome, lightweight and durable. Blends beautifully with the lines of the Ruger 77/22. Accepts all Weaver style rings and accessories. 4-1/2" long, available in black or silver, matte anodized finish, weighs 1.3 ounces.
Color Finish:
#WCR-077-22B Black
#WCR-077-22S Silver



Rifle Basix Ruger Trigger Bolt Action Rimfire 77/.22 & 77/.17

Fits Current Production 77/.22 & 77/.17 also fits .44 & .22 hornet
Weight of Pull: 1.5 lbs. to 3 lbs.
#RB-RU-R



Close-up of sights through scope base on a Ruger 1022.



Muzzelite Bullpup Stocks

The most striking feature of the Muzzelite Bullpup Stock, when attached to your action, is the overall length of 26-1/2". This allows you to carry the rifle with much greater mobility. Whether your sport is hunting or plinking, the Muzzelite Bullpup Stock will convert a long rifle into a compact weapon system in just a matter of minutes!

Construction is of fiberglass reinforced plastic and fits standard barrels and heavyweight barrels (with minor modifications).

#MZ-14 Approx. Length: 26.5"

TAPCO Intrafuse Mini-14/30 Rifle System

The Mini-14/30 T6 Stock provides the shooter six positions to adjust the weapon to any body frame. The SAW style pistol grip offers improved comfort and an internal storage compartments capable of holding spare weapon parts or cleaning supplies. Concealed beneath a removable cover, the forearm features a Picatinny rail capable of mounting forward grips and bipods. The included top barrel cover is equipped with an integrated rail designed to accept any Picatinny/Weaver style scope rings.

- #STT-STK62160-BLK Black
- #STT-STK62160-DE Dark Earth
- #STT-STK62160-OD Olive Drab

TAPCO T6 Rubber Buttpad

Easily installed on any T6 or M4 style collapsible stock, this rubber buttpad reduces the weapon's felt recoil while positioning the stock to the shoulder for better controllability.

#STT-STK90161 Black



Buffer Technologies Ruger, MINI-14/30 Recoil Buffer

The Mini-14/30 Recoil Buffer™ works the same as the M1A/M14 Buffer, by eliminating the operating rod contact with the receiver. The Mini-14/30 Recoil Buffer™ will protect your operating rod, the weak link in the system, from excessive shock.

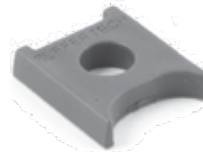

ATI Ruger Mini-14 Strikeforce - Buttstock & Forend Package

6 Position Collapsible Side Folding Buttstock with Adjustable Cheekrest & Buttpad
 FITS: All Ruger Mini-14 and Mini-30 (with serial number 181 or above). Minor modifications required for Mini-30.
 #118-ATI-RUG-2200-B

Weignad Mini 14 Ranch Rifle

Increase your scope options when you install this lightweight, Weaver-style rail on your Mini-14 Ranch Rifle. Lets you mount mini or short-length scopes as well as Tasco PDP4 or Aimpoint red dots without permanent modifications or Gunsmithing. Keeps the scope low over the centerline of the receiver to maintain optimum eye and scope alignment. Multiple cross slots allow adjustment for maximum eye relief. Accepts all Weaver-style rings and accessories. 5" long, silver or Black, matte anodized finish, weighs 2.6 ounces.



Fits the following Rifles: RUGER Mini 14 Ranch Rifle, Deerfield Mini 30, PC-40, PC-9, Carbine
 #WCR-RAN-CHB Black - Weaver Style
 #WCR-RAN-CHS Silver - Weaver Style
 #WCR-RAN-CHP Black - Picatinny

Weaver Rifle Base for Ruger Mini 14

These bases allow you to purchase the specific rings you want to suit your application. Rugged steel yoke design allows for easy installation

Color Mounts:
 #105-WVR-48644 Black
 #105-WVR-48646 Silver



Weaver Tactical Multi-Slot Mini 14 Bases

These versatile bases from Weaver help give your gun the tactical edge. Tactical Multi Slot Bases are constructed of tough, lightweight aluminum so they can withstand the most powerful recoil. Picatinny style to accept all Weaver Top Mount Rings and accommodate the mounting of devices such as scopes, red dots and laser optics, while allowing for optimal eye relief.

#105-WVR-48332 Multi Slot Mini 14



NcStar Mini 14 Mount

- Mini 14 Weaver Style Rail mounts directly to side of receiver
- Includes mounting hardware
- Length: 5.4"

#111-NCS-MMNB14 Black
 #111-NCS-MMNS14 Silver



Ruger 77/44, .44 and .44 Magnum Rifle and 77/22 Hornet Mount

No drill and tap Weaver style scope mount.
 #WCR-077-44S Silver
 #WCR-077-44B Black

Ruger 96, 96/44M Mount

No drill and tap Weaver style scope mount.
 #WCR-00R-96B Black



TAPCO Intrafuse SKS Rifle System

Transform your classic SKS from an antique rifle to a modern day tactical weapon. Our Intrafuse Rifle System replaces all original stock components with a high strength composite material.

- 1 SKS Railed Handguard for the Gas Tube (Gas Tube NOT Included)
- 1 SKS Stock Chassis for Blade Bayonet
- Installation Hardware
- 1 Six Position Butt-stock Assembly and Extension Tube
- 1 SAW Style Pistol Grip

- #STT-STK66166-BLK Black
- #STT-STK66166-DE Dark Earth
- #STT-STK66166-OD Olive Drab
- #STT-STK66167-BLK Black, w/ Blade Bayonet Cut
- #STT-STK66167-DE Dark Earth w/ Blade Bayonet Cut
- #STT-STK66167-OD Olive Drab w/ Blade Bayonet Cut
- #STT-STK66168-BLK Black, w/ Spike Bayonet Cut
- #STT-STK66168-DE Dark Earth w/ Spike Bayonet Cut
- #STT-STK66168-OD Olive Drab w/ Spike Bayonet Cut
- #STT-STK66169-BLK Black w/ Bottom Rail Attached
- #STT-STK66169-DE Dark Earth w/ Bottom Rail Attached
- #STT-STK66169-OD Olive Drab w/ Bottom Rail Attached

TAPCO SKS Accessories Shown in Olive Drab with Bottom Rail Attached



TAPCO SKS Shown in Black Blade Bayonet Cut

TAPCO Intrafuse SKS Rifle System

- 1 Intrafuse SKS Rifle System (show above) with Bottom Rail Attached

- #STT-STK66169-BLK Black
- #STT-STK66169-DE Dark Earth
- #STT-STK66169-OD Olive Drab

TAPCO AK/SKS Military Grade Windage & Elevation

Easily make adjustments to all AK and SKS variants.

#STT-TOOL0312

TAPCO AK/SKS Front Sight Adjustment Tool

This durable front sight adjustment tool works on both the AK and SKS weapons (except Yugo SKS). Reinforced with a metal insert, this tool allows for quick and easy elevation adjustments.

#STT-TOOL0301



ATI SKS Fiberforce Stock

The Ultimate in Military Styling with the Exclusive Fiberforce Dragunov Design!

#118-ATI-SKS-8000-B



AmeriGlo SKS Night Sight

#AGS-SKS-717 Front Sight, Green



ATI SKS 6 Position Side Folding Stock

6 Position Collapsible Side Folding Buttstock with Adjustable Cheekrest

#118-ATI-SKS-8000-B



Weaver Tactical SKS Multi-Slot Bases

These versatile bases from Weaver help give your gun the tactical edge. Tactical Multi Slot Bases are constructed of tough, lightweight aluminum so they can withstand the most powerful recoil. Picatinny style to accept all Weaver Top Mount Rings and accommodate the mounting of devices such as scopes, red dots and laser optics, while allowing for optimal eye relief.

#105-WVR-48331 Multi Slot SKS (STEEL)

NcStar SKS Tri-Rail & Receiver Cover

- Tactical SKS Weaver Style Tri-Rail and Receiver Cover
- Replaces existing SKS receiver cover
- Adjustable side weaver tabs
- Length: 4.8"

#111-NCS-MTSKS

NcStar SKS Gas Tube Mount

- SKS Gas Tube Weaver Style Mount
- Replaces existing SKS gas tube
- Length: 9.6"

#111-NCS-MSKS

TAPCO Yugo Muzzle Brake

Maintain the original look of your Yugoslavian 59/66 SKS by replacing the unused grenade launcher with our functional muzzle brake. Featuring 25 multi-directional ports that reduce recoil and increase control, this steel brake is machined with the same thread pitch as the original.

#STT-SKS6627

TAPCO SKS Scope Shield

Its universal design allows our deflector to interface with most receiver scope mounts on the market, including the Tri Rail Receiver Cover Mount. Once properly installed, it prevents damage to optics and loss of weapon's zero by deflecting spent cartridge casings.

#STT-MNT6608



Mourning Solutions Plus Presents: **ArmaDynamics**

PKM RAP MOUNT

1-800-428-9394
www.mourningplus.com

The PKM-RAP (Rail Adaptive Platform) system is designed to permit rapid, secure, and stable attachment of optical, electro-optical, or other accessories directly to the unmodified top cover of military standard Kalashnikov-type PKPKM/PMKMS/6P41 "Pecheriny" Light Machine guns.

World's Only Quick Attach/Detach Mount for the Kalashnikov-pattern Light Machine Gun series

- M1913 Mil-STD "Picatinny" rail with high precision mounting interface
- Multiple indexed rail slots for precision bore accessory mounting
- Simple, no-tool, insert and removal in seconds
- Proprietary mounting technology permits mounting even on damaged top covers

MS MOUNTING SOLUTIONS PLUS
1-800-428-9394 www.mourningplus.com

TAPCO AK-47 T6 Collapsible Stock

- Manufactured out of military grade composite to ensure high quality and strength
 - Six (6) position stock easily adjusts to body armor
- #STT-STK06160-BLK Black
 #STT-STK06160-DE Dark Earth
 #STT-STK06160-OD Olive Drab

TAPCO AK-47 SAW Style Pistol Grip

- Inspired by the M249 Squad Automatic Weapon, the AK SAW grip features a more ergonomic angle and increased width for greater comfort and control.
- #STT-STK06220-BLK Black
 #STT-STK06220-DE Dark Earth
 #STT-STK06220-OD Olive Drab

TAPCO Intrafuse AK-47 Handguard

- AK Intrafuse handguard set enhances the look and function of your AK-47. The lower handguard houses a concealed Picatinny rail. The matched upper handguard offers increased heat dissipation and improved styling and includes a Picatinny rail.
- #STT-STK06311-BLK Black
 #STT-STK06311-DE Dark Earth



TAPCO AK-47 Muzzle Brakes

- 1 #STT-AK0679 TAPCO AK-74 Style Muzzle Brake
- 2 #STT-MNT0685 Tapco M16-Style AK Muzzle Device
- 3 #STT-AK0687 Tapco AK-47 Cage Muzzle Brake
- 4 #STT-AK0687 TAPCO AK-47 Cage Muzzle Brake
- 5 #STT-AK0684 TAPCO AK-47 Slant Muzzle Brake

TAPCO AK-47 Original Style Butt-stock

- Patterned after the original Bulgarian fixed stock for the AK, this stock allows you to retain the original look of your AK while adding a compliance part.
- #STT-STK06101-BLK Black
 #STT-STK06101-DE Dark Earth
 #STT-STK06101-OD Olive Drab

TAPCO AK-47 Original Style Pistol Grip

- TAPCO AK Original Pistol grip. For stamped receiver AK's. Styled after the original soviet bakelite AK grips.
- #STT-STK06201-BLK Black
 #STT-STK06201-DE Dark Earth
 #STT-STK06201-OD Olive Darb

TAPCO AK G2 Trigger Groups

- Whether building a new rifle or upgrading your current AK, the G2 trigger group should be at the top of your list. Our trigger groups offer an improved trigger pull of 3-4 lbs. and eliminate the painful trigger slap common on other designs.
- #STT-AK0650-S Single
 #STT-AK0650-D Double



TAPCO AK-47/74/Saiga Gas Piston

- Universal gas piston works in standard AK-47's, AK-74's, Tantals, and even Saiga Rifles.
- #STT-AK0659



TAPCO AK Grip Screw and Bushing

- #STT-AK06211
-

TAPCO Intrafuse AK-47 Quad Rail Handguard

- Expanding on all of the benefits of the basic Intrafuse Handguard, this enhancement adds two side rails perfect for mounting lights.
- #STT-STK06312-BLK Black
 #STT-STK06312-DE Dark Earth
 #STT-STK06312-OD Olive Drab



TAPCO AK Accessories Shown in Dark Earth

TAPCO AK-47 Galil Style Handguard

- Reduces heat and improves ventilation by providing a greater cooling area around the barrel. Modeled after the original Galil pattern.
- #STT-STK06310-BLK Black
 #STT-STK06310-DE Dark Earth
 #STT-STK06310-OD Olive Drab



TAPCO AK-47 Folding Stock

- Designed after the original Galil pattern
 - Constructed from military grade composite
- #STT-STK06150-BLK Black
 #STT-STK06150-DE Dark Earth
 #STT-STK06150-OD Olive Drab



TAPCO Intrafuse AK Folding Stock Rifle System

- Package Includes:
- AK Folding Stock
 - AK Galil Style Handguard
 - AK SAW Pistol Grip
- #STT-ZSTK06150-BLK Black
 #STT-ZSTK06150-DE Dark Earth
 #STT-ZSTK06150-OD Olive Drab

TAPCO Intrafuse AK T6 Stock Rifle System

- Package Includes:
- AK T6 Collapsible Stock
 - AK Galil Style Handguard
 - AK SAW Pistol Grip
- #STT-ZSTK06160-BLK Black
 #STT-ZSTK06160-DE Dark Earth
 #STT-ZSTK06160-OD Olive Drab



Ameriglo AK-47 Front Night Sight
 #AGS-AK-715 All Using M6 x.075 thread front

Ameriglo AK-47 Rear Night Sight
 #AGS-AK-961R Chinese (Norinco, PolyTech) 800 meter AKS
 #AGS-AK-981R 7.62 x 39 Models, 1000 meter markings AKM
 #AGS-AK-991R 5.45 x 39 Models, 1000 meter markings AK74

Samson AK-47 Rear Sight Rail

It is made from Steel, Mounts, directly to the Rear sight mount on the AK-47. Fits all AK 47 models with rear sight. Features a rear sight picture for see under optic Back up iron sight use.

#SMC-AK-RSR1



Samson Field Survivor AK Tool

This kit is all you need to have a tool kit on your AK Rifle. Always! We combined the classic Hogue Overmolded AK Grip with our Field Survivor tool in this kit.

#SMC-FST-AK Field Survivor Tool AK.
 #SMC-FST-HAK Field Survivor Tool AK w/ Hogue Grip

Samson AK-47 Cheek Rest

Fits both left and right and adjustable front and back up and down. Attaches easily. Stock can still be folded

#SMC-AK-UADJ-CR



ATI AK Strikeforce Collapsible, Side Folding Buttstock w/Adjustable Cheekrest & Buttpad

Six-Position Collapsible/Side Folding. Folds to the Left Side of the Receiver .
 FITS: All AK Variants (Stamped Receivers)
 #118-ATI-AKA3600-B

ATI AK-47 Strikeforce Handguards (Upper and Lower) with Picatinny Rails & Inserts

Ergonomic Design, Ventilated Upper & Lower Handguards with one 4" and Three 2" Picatinny Rails
 #118-ATI-AKA3500-B



ATI AK-47/MAK-90 Fiberforce Stock

Fiberforce Dragunov Design for Military Look & Style
 FITS: AK, MAK-90 and MAADI (all AK-47 variants) 7.62 x 39 cal.
 #118-ATI-MAK0100



TAPCO Intrafuse Saiga T6 Stock Set

Constructed of reinforced composite, our system includes a 6 position T6 Adjustable Stock Assembly, a SAW style Pistol Grip, Rubber Buttpad, and all necessary mounting hardware.

Designed for easily installation, the end user simply removes the standard Butt-stock assembly and replaces it with our stock system.

#STT-STK07160-BLK Black
 #STT-STK07160-DE Dark Earth
 #STT-STK07160-OD Olive Drab

TAPCO Intrafuse Saiga Handguard

This versatile handguard is a crucial addition to anyone upgrading their Saiga rifle or shotgun. With the optional side and bottom rails this modular unit is designed for maximum flexibility to fit the user's ideal configuration. The handguard comes with everything needed to adapt to the Saiga 7.62 x 39mm, .223, .308, or the 12 & 20ga Saiga shotguns.

#STT-STK07320-BLK Black
 #STT-STK07320-DE Dark Earth
 #STT-STK07320-OD Olive Drab

ERGO Classic AK Grip

- Ambidextrous design with smooth finger grooves
- Superior textured finishes for enhanced weapon control
- Bottom storage compartment with tethered rubber plug
- SUREGRIP is an over molded rubber surface resembling the consistency of a pencil eraser and offers the user a grip with a little give

#119-EG-4139-BK



Samson K-Rail Model for the AK Family

Two piece design clamps to the barrel trunion area. Low upper rail with clearance slot for use of iron sight. Four 1913 mil spec rails for mounting all popular lights and accessories. Lower rail cut out for underfolder stock. Side clearance for side folding stock.

#SMC-KRAIL-M1 for the AK046
 #SMC-KRAIL-M2 for the Krinkov
 #SMC-KRAIL-M3 for the Bulgarian Krinkov



NcSTAR AK-47 Tri-Rail & Receiver Cover

AK-47 Weaver Style Tri-Rail Mount and Tri-Rail and Receiver Cover
 #111-NCS-MTAK



A.R.M.S. #1 G-3/MP-5 Claw Mount

Designed to fit the HK-91-93-94, MP5 and SP89. The A.R.M.S. G-3 locks solidly to the upper receiver of the rail while allowing use of the iron sights. The mounting platform provides the A.R.M.S. Universal rail to accept both STANAG and dovetail fastenings, for both day optics, night vision and lasers, as required. STANAG rings and rails can also be utilized. The A.R.M.S. G-3 is manufactured from 4140 steel and phosphate finished black to spec DOD-16232.

- 1 #ARMS-1 A.R.M.S. #1
- 2 #ARMS-1S A.R.M.S. #1S Shorty

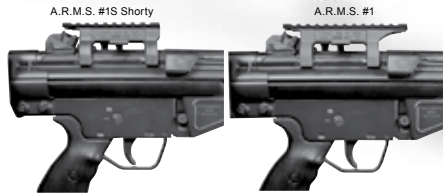

Magpul HK PRS-G3

Fits any HK variant that has a factory fixed-stock steel backplate and standard buffer (not included). Compatible models include: HK91, HK93, HKG3, HK33, PTR91, SR9.
#MAG-340-BLK

MFI HK Low Profile Scope Mount

Low Profile Mounts for HK Rifles and Alternative Mounts for Clones that do not meet EXACT HK specifications.

- 3 #MFI-HK-LOW



HK Mount Low Profile with Accessories

- 4 #AIM-10266

A.R.M.S.#1SHRAIL Special 6" Extension Rail

For Extra Eye Relief, (Shown on A.R.M.S.#1S)
#ARMS-1-SH-RAIL



Samson STAR HK MP5 Handguard Rail

Two piece design clamps to barrel trunion area and mounts to the front handguard mounting point. No permanent modifications to the weapon are required. Three 1913 mil spec rails. Cleared for charging handle.

- 5 #SMC-STAR-MP5 MP5 Handguard with Side Rails
- 6 #SMC-STAR-MP5-LP MP5 Handguard Low Profile
- 7 #SMC-STAR-MP5K MP5K Handguard with Side Rails
- 7 #SMC-STAR-MP5K-LP MP5K Handguard Low Profile

ERGO HK Tactical Grip with Palm Shelf

- #119-EG-4190 HK Grip, SUREGRIP - Right Hand, Black
- #119-EG-4055 HK Grip, RIGID - Right Hand, Black



L&M MP-5SD Mount for Laser & Tactical Flashlight

L&M submachine gun mounts are precision machined, hard black anodized with a non-reflective finish and supplied with black oxide coated steel mounting screws that resist stripping. Mounting hardware and hex key included.

- 8 #123-LMS-MP5-SDS Single Mount
- 9 #123-LMS-MP5-SDD Double Mount

L&M MP-5SD 3 Rail MIL-SPEC Adapter Mount for Suppressor

- 10 #123-LMS-MP5-SD



PRI Galil Base

Lightweight mount that attaches to side of the receiver using dovetailed mounting block.
#PRI-CUS-GAL

A.R.M.S. #18 M21/M14 Mount

Since its introduction to the marketplace in 1989, this foundation has maintained its reputation as being the best mounting systems for the M21/14 Rifle. The A.R.M.S. #18 offers interchangeability of Day & Night Vision, with an ultra low profile and the A.R.M.S. SWAN aka Mil-Std. 1913 Rail. Made of 8620 case hardened steel. Precision fit to the base integral with the receiver. Two attaching points plus a third contact point for ultimate stability.

NSN 1240-01-316-0055
#ARMS-18



A.R.M.S. #18 M21/14 Mount with 21 STANAG Rings



Sadlak Industries M14/M1A Service Tools

Includes:
Oversized-Wrench
Gas Cylinder Wrench Combo Tool
Cleaning Drill Set Drill Set
#SIL-4PC-TLKT

Sadlak Industries M14/M1A Cleaning Drill

#SIL-140201 - for Gas Plug Cleaning

Sadlak Industries M14/M1A 2pc Drill Kit

#SIL-140200 - for Piston Cleaning

Sadlak M14/M1A Gas Cylinder Wrench

#SIL-140100

Sadlak Industries M14/M1A Steel Scope Mount

The Brookfield-type scope mounts are a positive 3-point design that allows removal and re-assembly without losing zero. The Picatinny-style rail is machined to Mil. Spec 1913 and provides universal scope mounting.

#SIL-140011

Sadlak Industries M14/M1A Airborne Steel Mount

Airborne Model Steel Scope Mount 9.0 oz

- 20% Lighter than our standard steel mount
- Precision Mil-Spec Picatinny Rail and see-thru U-Channel for Iron sight us

#SIL-140015

Sadlak Industries M14 Aluminum Mount

Made to the exact same precise specifications, with every feature as our steel and titanium models. Used by the military but with such an affordable price that every sportsman can now afford one.

#SIL-140012

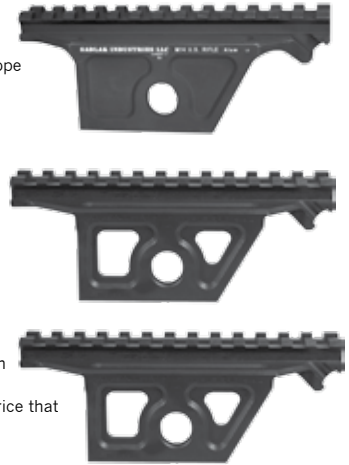

Sadlak M14 National Match Spring Guide

Our National Match Spring Guide improves the consistency and smooth motion of the operating rod which helps reduce wear and increase rifle accuracy over the standard stamped GI guide.

#SIL-140020

Piston for M14 Titanium

#SIL-140032



Ameriglo M14 / M1A Front Night Sight

1 Dot (Green tritium dot)
#AGS-MF-615



Buffer Technologies M1A / M14 Recoil Buffer

#BUFT-M1A



Tactical Mag Release Latch

#SIL-140040



A.R.M.S. #3 & #4 FN FAL Mount

The A.R.M.S. FN FAL standard and paratrooper are precision machined to military specifications. This mount replaces the existing dust cover and offers the user a rigid mounting base with NATO standard weaver rail and picatinny rails. This mount will fit L1A1 and FAL rifles. Manufactured from aluminum extrusions with steel attachment rails riveted in place. The exceptional rigid alloy body provides a rock solid platform for even the largest optics.

FN FAL A.R.M.S. #3
#ARMS-3

FN FAL A.R.M.S. #4
Paratrooper Model
#ARMS-4

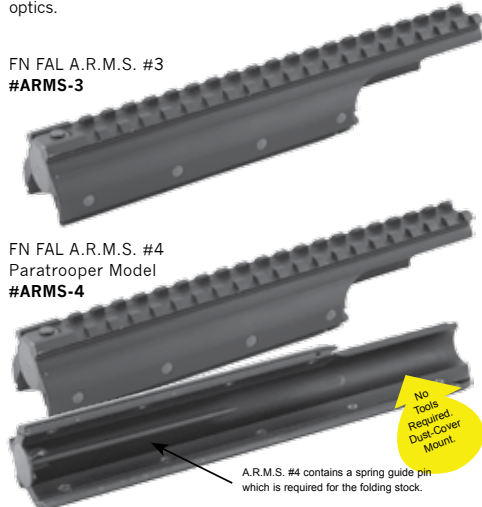

A.R.M.S. #4 contains a spring guide pin which is required for the folding stock.

ERGO FAL Metric Grip, SUREGRIP, Black

- Ambidextrous design with smooth finger grooves
- Superior textured finishes for enhanced weapon control
- Bottom storage compartment with tethered rubber plug
- SUREGRIP is an over molded rubber surface resembling the consistency of a pencil eraser and offers the user a grip with a little give

#119-EG-4106-BK



TAPCO FAL Accessories Shown in Olive Drab

TAPCO FAL Gas & Sight Tool

This heavy duty sight tool is made of 4140 steel and heat treated for strength. Making difficult tasks easy, our tool assists in gas tube removal or installation and when making adjustments to the front sight or gas system.

#STT-TOOL2405



TAPCO FAL Front Sight Tool/SKS Crossbolt Tool

Durable and compact, this tool allows for quick removal of the crossbolt. Working end features a metal insert for strength.

#STT-TOOL0307



Magpul FN FAL PRS-FAL

Adjustable for cheek weld height, length of pull, and cheek weld placement, the Precision Rifle/Sniper (PRS™) stock offers adjustability in a drop-in form for the FAL metric pattern rifle, while still utilizing the factory standard buffer unit

#MAG-341-BLK

TAPCO FAL SAW Style Pistol Grip

Adapted from the M249 Squad Automatic Weapon, this FAL grip offers a more ergonomic angle and increased width for greater comfort and control. Originally designed for a light machine-gun, this grip will easily handle the recoil of the 7.62 NATO cartridge. Inside the grip housing is a useful storage compartment. Fits Metric rifles only.

#STT-STK24220-BLK Black
#STT-STK24220-OD Olive Drab

TAPCO FAL SAW Butt-stock

Stronger than the original FAL stock, the SAW Butt-stock adds modern day strength and style to the classic design. Manufactured from military grade composite, this model features a non-slip ribbed buttplate and flip-up wire shoulder support. This high strength composite Butt-stock is designed for the metric FAL only.

#STT-STK24180-BLK Black
#STT-STK24180-OD Olive Drab

PRI Remington 700 Short Action 6" Cut Out Bases

6" Mil. Spec rail, milled 4140 steel construction.
 #BRP-SSA-010 Short Action, #6 screws



PRI Remington 700 Short Action 7" Cut Out Bases

7" Mil. Spec rail, milled 4140 steel construction.
 #BRP-SSA-017 Short Action, #6 screws

PRI Remington 700 Short Action 7" Left Handed Cut Out Bases

7" Mil. Spec rail, milled 4140 steel construction.
 #BRP-SSA-LHA Short Action, #6 screws

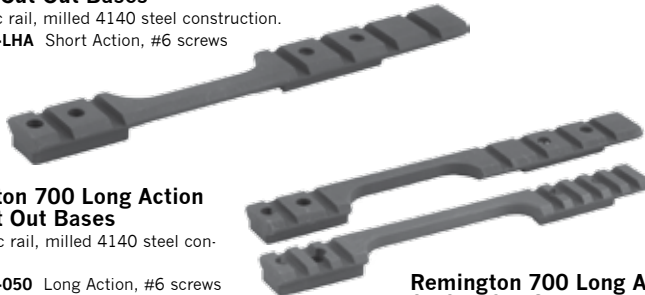

Remington 700 Long Action 2.5" Cut Out Bases

7" Mil. Spec rail, milled 4140 steel construction.
 #BRP-SLA-050 Long Action, #6 screws



Remington 700 Long Action 3.125" Cut Out Bases

7" Mil. Spec rail, milled 4140 steel construction.
 #BRP-SLA-040 Long Action, #6 screws

PRI Remington 700 6" Full Rail Base

6" Mil. Spec rail, milled 4140 steel construction.
 #BRP-FPR-SA2 Short Action, #6 screws
 #BRP-FPR-SA8 Short Action, #8-40 screws

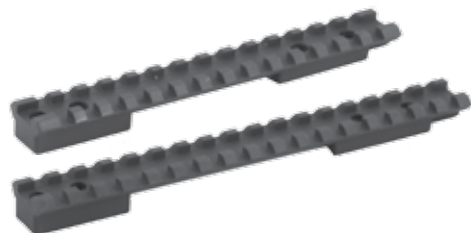

PRI Remington 700 2 Piece Bases

2 Piece Mil. Spec rail, milled 4140 steel construction.
 #BRP-SSA-020

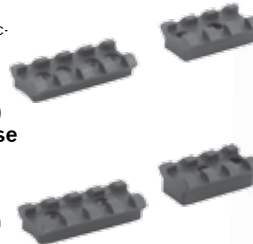

PRI Remington 700 2 Piece X-Thick Base

2 Piece Mil. Spec rail, milled 4140 steel construction. Designed to accommodate scopes with 50mm objectives
 #BRP-SSA-030

PRI Remington 700 7" Full Rail Base

6" Mil. Spec rail, milled 4140 steel construction.
 #BRP-FPR-SA1 Short Action, #6 screws
 #BRP-FPR-SA18 Short Action, #8-40 screws
 #BRP-FPR-LA6 Long Action, #6 screws
 #BRP-FPR-LA68 Long Action, #8-40 screws

Remington 700 Base with Extra Rear Eye Relief

9" Mil. Spec rail, milled 4140 steel construction.
 #BRP-FPR-LA9R Long Action, #6 screws
 #BRP-SLA-84B Long Action, #8-40 Screws
 #BRP-FPR-SA9R Short Action, #6 screws

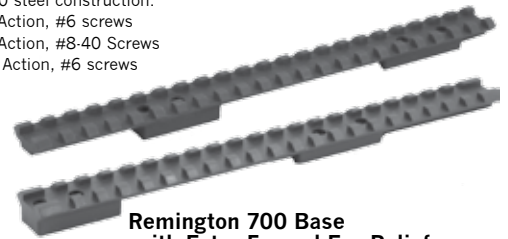

Remington 700 Base with Extra Forward Eye Relief

9" Mil. Spec rail, milled 4140 steel construction.
 #BRP-FPR-LA9F Long Action, #6 screws
 #BRP-FPR-SA9F Short Action, #6 screws

PRI Remington 700 MOA Bases

Long distance with additional eye relief,
 7" Mil. Spec rail, milled rugged aluminum.
 #BRP-ASP-040 S/A 15 MOA, #6 screws
 #BRP-ASP-045 S/A 20 MOA, #6 screws
 #BRP-ASP-047 S/A 25 MOA, #6 screws
 #BRP-ASP-060 L/A 15 MOA, #6 screws
 #BRP-ASP-055 L/A 20 MOA, #6 screws
 #BRP-ASP-050 L/A 25 MOA, #6 screws



Nightforce Remington 700 Bases w/ 20 MOA

An integral recoil lug machined on the bottom of the base provides a precise fit when bedded to the rifle's action, preventing any movement of the base or recoil stress on screws holding the base to the receiver. (Bedding Compound not included)

One-piece bases are machined to exact Picatinny Mil. Std. 1913 specification rail dimensions. This design allows the same scope to be used on several different rifles, always optimizing eye relief with 20 M.O.A. tapers. Designed for right- or left-hand actions, our bases will never interfere with loading or extraction.

#117-NF-700SA120 Short Action Steel Bases w/ 20 MOA
 #117-NF-700LA120 Long Action Steel Bases w/ 20 MOA



PRI Side Rail Attachments

This side rail is designed to mount on the side of the BAR rails or the VZ58 rail system. The rail is constructed of hard coat aluminum and is attached with 3 socket head screws.

#BRP-SP-SA-4SR

PRI Remington 700 16" Bar Night Vision Rail

For Add Night Vision added to front of scope

Aluminum base with full 1913 rail has two different elevations. It's designed to place night vision in front of the scope. Mounting will require altering of the receiver. Rail has additional mounting holes on each side so additional rails can be added for flashlights or other optics.

#BRP-021608 Short Action, #8-40 screws
 #BRP-021708 Long Action, #8-40 screws

Weaver Remington 700 Two Piece Dovetail Bases

Two Piece all-steel bases provide recoil resistance and feature the dovetail locking system for an ultra-secure, positive lock-on rings.

- #105-WVR-48901 2pc Remington 700 LA/SA Matte
- #105-WVR-48971 2pc Remington 700 LA/SA Nickel



Weaver Remington 700 Dovetail Bases

One Piece all-steel bases provide recoil resistance and feature the dovetail locking system for an ultra-secure, positive lock-on rings.

- #105-WVR-48912 1pc Remington 700 LA Black
- #105-WVR-48913 1pc Remington 700 LA Matte
- #105-WVR-48930 1pc Remington 700 SA Black



Weaver Savage Dovetail Bases

Piece all-steel bases provide recoil resistance and feature the dovetail locking system for an ultra-secure, positive lock-on rings.

- #105-WVR-48918 1pc Savage 110 LA Original Black
- #105-WVR-48920 1pc Savage 110 SA Original Black



Weaver Savage 2 Piece Dovetail Bases

2 Piece all-steel bases provide recoil resistance and feature the dovetail locking system for an ultra-secure, positive lock-on rings.

- #105-WVR-48902 2pc Savage LA/SA Original Style Black
- #105-WVR-48903 2pc Savage LA/SA Original Style Matte
- #105-WVR-48972 2pc Savage LA/SA Original Style Nickel
- #105-WVR-48906 2pc Savage LA/SA Accu-Trigger Matte



Milling Block with Two Attaching Rails

Holds long or short Mil-Spec Rails for easy and fast machining. With A.R.M.S. #17 and 35 QD Bases included.

#LLR-GST-003



Milling Block only

The only easy and simple way to hold a Picatinny rail for base milling. Base Unit Only.

#LLR-GST-002

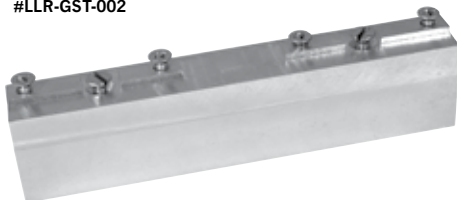

PRI Savage Short Action Base

Tactical Base 4140 steel construction compatible with all Mil. Spec. products.

- #BSP-SSA-010 Original Style
- #BSP-SSA-025 Accu-Trigger



PRI Savage Long Action Base

Tactical Base 4140 steel construction compatible with all Mil. Spec. products.

- #BSP-SLA-040 Original Style
- #BSP-SLA-065 Accu-Trigger



Original Short Action One Piece Full Rail

Full Mil. Spec rail, 4140 steel construction.

- #BSP-FPR-S14 Original Style
- #BSP-FPR-S35 Accu-Trigger

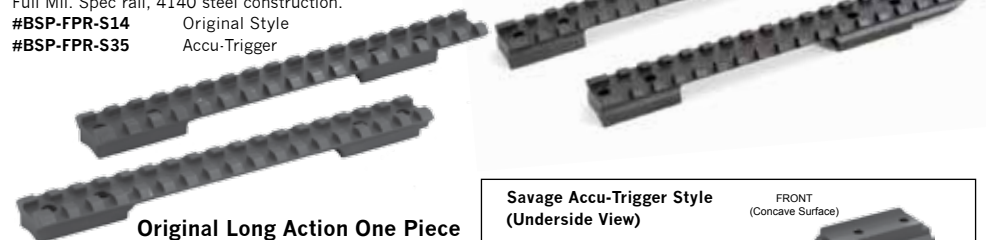

Original Long Action One Piece Full Rail

Full Mil. Spec rail, 4140 steel construction.

- #BSP-FPR-LA6 Original Style
- #BSP-FPR-L75 Accu-Trigger

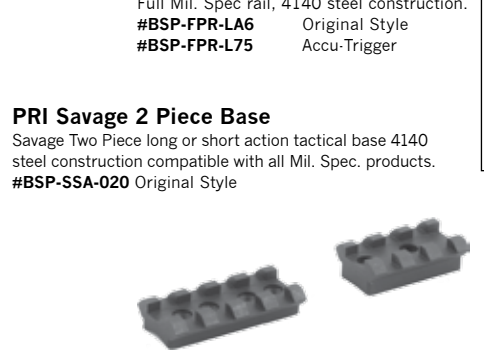

PRI Savage 2 Piece Base

Savage Two Piece long or short action tactical base 4140 steel construction compatible with all Mil. Spec. products.

- #BSP-SSA-020 Original Style



Nightforce Savage (Accu-Trigger) Steel Bases w/ 20 MOA

An integral recoil lug machined on the bottom of the base provides a precise fit when bedded to the rifle's action, preventing any movement of the base or recoil stress on screws holding the base to the receiver.

Our one-piece bases are machined to exact Picatinny Mil. Std. 1913 specification rail dimensions. This design allows the same scope to be used on several different rifles, always optimizing eye relief. With 20 M.O.A. tapers. Designed for right-or left-hand actions, our bases will never interfere with loading or extraction.

- #117-NF-SAVASA-120 Short Action Steel Bases w/ 20 MOA
- #117-NF-SAVALA-120 Long Action Steel Bases w/ 20 MOA



Savage Accu-Trigger Style (Underside View)

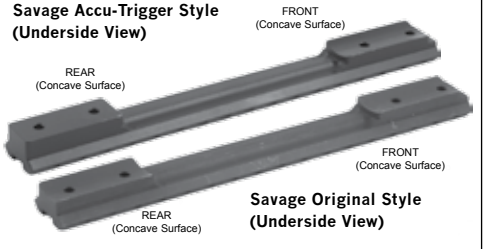

FRONT (Concave Surface)

REAR (Concave Surface)

FRONT (Concave Surface)

Savage Original Style (Underside View)

REAR (Concave Surface)

Can't find it? Build it!

Build Your Own Mil-spec Aluminum Rails

.75" thick

- #BYO-PAL-018 18" Length
- #BYO-PAL-008 8.875" Length
- #BYO-PAL-005 5.625" Length

Build Your Own Mil-spec Steel Rails

.525" thick

- #BYO-PST-018 18" Length
- #BYO-PST-008 8.875" Length
- #BYO-PST-005 5.625" Length

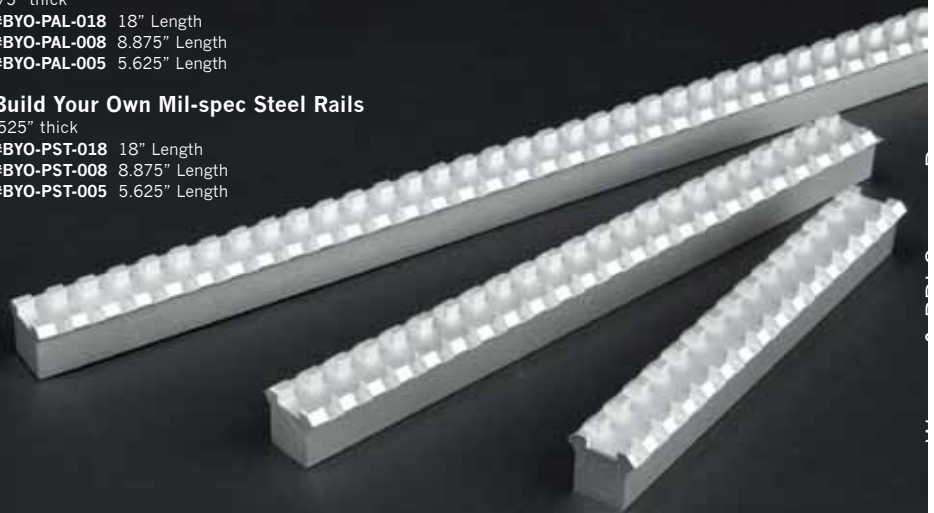

PRI Special Bases

PRI Accuracy Conversion Base

Converts Accuracy Base to Mil Spec. High strength aluminum construction.

#PRI-ARC-001



PRI Sig 542 Base

Mil-Spec rail, milled high strength aluminum construction.

#PRI-SIG-542

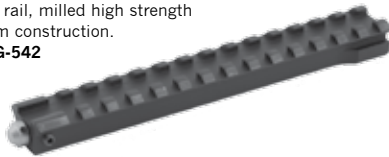

1pc Thompson Center Encore

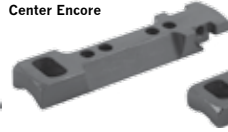

1pc Remington 7400, 4&6



1pc Browning Mark II



1pc Springfield

2pc Winchester 70

Grand Slam Steel Dovetail Rings

Offered as a one or two-piece system, these all-steel bases provide recoil resistance and feature the dovetail locking system for an ultra-secure, positive lock-on rings

- #105-WVR-48904 2pc Browning A-Bolt LA/SA Black
- #105-WVR-48905 2pc Browning A-Bolt LA/SA Matte
- #105-WVR-48922 1pc Browning A-Bolt LA Black
- #105-WVR-48923 1pc Browning A-Bolt LA Matte
- #105-WVR-48924 1pc Browning A-Bolt SA Black
- #105-WVR-48925 1pc Browning A-Bolt SA Matte
- #105-WVR-48932 1pc Browning Mark II Black
- #105-WVR-48933 1pc Browning Mark II Matte
- #105-WVR-48911 2pc Browning A-Bolt WSSM Matte
- #105-WVR-48928 1pc Marlin 336 Black
- #105-WVR-48929 1pc Marlin 336 Matte
- #105-WVR-48954 1pc Mauser FN Black
- #105-WVR-48952 2pc Mauser FN Black
- #105-WVR-48958 1pc Marlin 1894 Black
- #105-WVR-48916 1pc Mauser 98 Black
- #105-WVR-48910 2pc Mauser 98 Black
- #105-WVR-48900 2pc Remington 700 LA/SA Black
- #105-WVR-48901 2pc Remington 700 LA/SA Matte
- #105-WVR-48971 2pc Remington 700 LA/SA Nickel
- #105-WVR-48912 1pc Remington 700 LA/SA Black
- #105-WVR-48913 1pc Remington 700 LA Matte
- #105-WVR-48930 1pc Remington 700 SA Black
- #105-WVR-48931 1pc Remington 700 SA Matte
- #105-WVR-48914 1pc Remington 7400, 4&6 Gloss
- #105-WVR-48915 1pc Remington 7400, 4&6 Matte

- #105-WVR-48948 1pc Remington 740, 4&6 Gloss
- #105-WVR-48962 2pc Sako Black
- #105-WVR-48902 2pc Savage 110 LA/SA Black
- #105-WVR-48903 2pc Savage 110 LA/SA Matte
- #105-WVR-48972 2pc Savage 110 LA/Sa Nickel
- #105-WVR-48906 2pc Savage 110 LA/SA Accu-Trigger Matte
- #105-WVR-48918 1pc Savage 110 LA Black
- #105-WVR-48920 1pc Savage 110 SA Black
- #105-WVR-48966 1pc Springfield Black
- #105-WVR-48968 1pc Springfield 03A3 Black
- #105-WVR-48926 1pc Thompson Center Encore
- #105-WVR-48976 2pc Weather by Mark V Black
- #105-WVR-48908 2pc Winchester 70 (.860 Spacing) Black
- #105-WVR-48909 2pc Winchester 70 (.860 Spacing) Matte
- #105-WVR-48934 2pc Winchester 70 (.435 Space & Pre-64) Black
- #105-WVR-48935 2pc Winchester 70 (.435 Space & Pre-64) Matte
- #105-WVR-48907 2pc Winchester 70 Wssm Matte
- #105-WVR-48940 1pc Winchester 70 Sa-1984 Black
- #105-WVR-48936 1pc Winchester 70 (Pre-64) Black
- #105-WVR-48938 1pc Winchester 70 (.860 Space) Black

Weaver Steel Top Mount Bases

Precision-built steel bases are machined to tight tolerances for a custom fit. A square-cut notch mates to the sturdy cross bolt in every Weaver top mount Ring. Custom-hardened fastening screws included.

#105-WVR-48223	S25	#105-WVR-48244	S49A	#105-WVR-48275	S459
#105-WVR-48224	S35	#105-WVR-48230	S54	#105-WVR-48276	S460
#105-WVR-48225	S36	#105-WVR-48231	S55	#105-WVR-48282	S466
#105-WVR-48243	S40A	#105-WVR-48234	S61		
#105-WVR-48226	S45	#105-WVR-48241	S91		
#105-WVR-48227	S46	#105-WVR-48247	S402		
#105-WVR-48228	S47	#105-WVR-48249	S430		

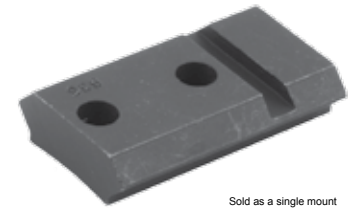

Sold as a single mount

Weaver Mount Applications Chart	Standard		Extension	
	Rear	Front	Rear	Front
Model				
Anschutz 54, 54ms, 64, 64ms, 164, 1400 Series, 1500 Series 1568	S91	S91		
Beretta Mato Rifle	S49A	S46		
Pintail Slug Gun	S35	S35	S40A	S40A
Browning A-Bolt, A-Bolt 22 Stalker; Medallion Bolt Action Bbr, Hi-Power, Other Cal. (Older Mod.)	S47	S47		
BAR, BAR II, Mark II, BLR Lightning (Lever), BPR BLR (Lever Action)	S54	S54		
BBR (Bolt Action), Long & Short Actions	S47	S46		S402
Bsa Monarch Medium Action In 222, 243 & 308 CF2, Monarch Long Action In 7mm, 270 & 30-06	S36	S35	S36	S35
Carl Gustaf Mod 2000	S460	S460		
Churchill Highlander 950 & 950-C	S36	S36		S40A
972-C	S61	S46		S402
Colt 57	S45	S46		S402
Coltsman In 223, 243 & 308 Cal. (Round Receiver)	S25	S25		
Coltsman In 264 & 30-06 Cal. (Round Receiver)	S54	S54		
Sauer	S35	S35	S40A	S40A
Cooney 71	S47	S46		S402
Enfield With Receiver Cut Down Like: Winchester 70	S47	S46		S402
Remington 721	S36	S35		S40A
H & R 300, 301, 330 & 370 (Pre 1973)	S45	S46		S402
300 & 301 L.A. In 270, 30-06, 7mm & 300 Win (1973+)	S54	S46		S402
Herters J9	S45	S46		S402
U9 Round Receiver	S36	S35		S40A
High-Standard High-Power	S55	S46		

Weaver Mount Applications Chart	Standard		Extension	
	Rear	Front	Rear	Front
Interarms				
Viscount	S45	S46		S402
Ithaca LSA-55 & LSA-65 Knight Muzzleloaders	S61	S61		
Knight MK-85, BK-92 & T-Bolt (Flat Receivers)	S61	S61		
LK-93, Wolverine, Legend, Disc, American, Revolution Legacy	S45	S45		
Howa Marlin 45, 30AS 336 (All Models) 444, 1893, 1895, CAMP 9, 455	S36	S35		S40A
MR7	S466	S466		
Mausier Receiver Ring About 1.410" Diameter (98FN)	S45	S46		S402
Receiver Ring About 1.300" Diameter (Swedish 96)	S55	S46		S402
Mossberg 680, 800 & 695-Shotgun (Use Dual Extension Rings)	S55	S55		
100 Atr, 1500, 1700	S36	S35		S40A
Musgrave Mark I & Mark II	S45	S46		S402
Mark III & Mark IV	S45	S46		S402
Navy Arms Country Boy Muzzleloader	S46	S46	S402	S402
Parker-Hale 1000, 1000c, 1100, 1200 & 1700	S45	S46		S402
Raptor Arms Same As Remington 700 Long Action	S36	S35		S40A
Remington 700, 78, 40x-L, 721 & 725 (All Long Actions)	S36	S35		S40A
700, 78, 40x-S, 722 & 725 (All Short Actions), 700 MZL. LDR.	S36	S35		S40A
7 W/4 Holes (New In 1999), 673	S430	S460		
Sauer 200	S35	S35	S40A	S40A
202	S459	S460		
SHR 970	S25	S25		

Weaver Mount Applications Chart	Standard		Extension	
	Rear	Front	Rear	Front
SAKO				
SAKO 516 S/A, 10 ML (2-Piece Only) Pre 2003 Models	S61	S61		
Pre 2003 Models	S61	S46		S402
10, 12, 110, 112 Series, W/ Accutrigger,, Stevens 200, 10 MI II	S46	S46	S402	S402
Schultz & Larsen	S54	S45		S402
Sears 50 & 51	S45	S46		S402
511	S55	S46		S402
53	S47	S46		S402
Shilen Flat Top Receiver	S61	S61		
Round Receiver	S35	S35	S40A	S40A
Smith & Wesson Mauser Actions W/Small Rec. Ring About 1.30" Dia 1500, 1600 & 1700	S55	S46		S402
Springfield 03	S36	S35		S40A
Stevens 110e	S54	S55		
Savage/Stevens 200	S61	S46		S402
Tikka Tikka W/Flat Receiver	S46	S46	S402	S402
Voere 2150, 2165/1, 2165/2, 2165/3 & 2165/4 (Mauser Action)	S61	S61		
Weatherby Vanguard	S45	S46		S402
FN Mauser Style Actions	S36	S35		S402A
Western Field 775 & 780	S45	S46		S402
Winchester (Includes Ranger Models) 52 (Hole Spacing Same)	S55	S55		
70 Long Action (Hole Spacing Same), 670, 770	S46	S46	S402	S402
70 Long Action (Hole Spacing Different) & 70 Super Express)	S47	S46		S402
70 Short Action (1984+)	S49A	S46		S402

Rifle Basix Triggers

Rifle Basix after-market triggers feature state of the art CNC machined housings made from T6 6061 billet aluminium and are black anodized for a factory appearance. All internal levers are investment cast from A-2 tool steel, CNC machined and heat treated for excellent wear characteristics. The levers are electroless nickel plated for smooth operation and a bright appearance.

Remington Trigger L-1

General purpose hunting. 1.5 lbs. to 4 lbs. Factory adjusted to break at 2.3lbs. Will service Remington models 700, 40X, Model 7, XR-100 and the rear grip XP-100 pistol.

#RB-L-1 Black
#RB-L-1-S Silver



Remington Safety Kit

Fits all Rifle Basix Remington Triggers, and Remington Factory Triggers manufactured before 2006.

#RB-REM-SAF



Ruger Centerfire Replacement Sear

Centerfire Rugers with Tang Safety Replacement Sear
14 oz. to 2 lbs.

#RB-RU-T



Rifle Basix Ruger Trigger - Bolt Action Rimfire

77/.22 & 77/.17

Fits Current Production 77/.22 & 77/.17 also fits .44 & .22 hornet
Weight of Pull: 1.5 lbs. to 3 lbs.

#RB-RU-R



Savage Trigger SAV-1

All 110 Type Rifles Long & Short
• Early & Late

• Left & Right Hand

Models: 10, 11, 12, 110, 16, 111, 112, 114 & 116

Will replace standard trigger or AccuTrigger. Also fits Savage/Stevens Model 200. Weight of Pull: 1 lb. to 3 lbs.

#BR-SAV-1



Marlin Trigger MAR-917

2004 Marlin Rimfire
2004 Bolt Action Models with T-900 Trigger Systems

Models: 915, 917, 925, 980, 982 & 983
Weight of Pull: 1 lb. to 2 lbs.

#RB-MAR-917



Remington Trigger

Live varmint hunting. 8 oz. to 1.5 lbs. Factory adjusted to break at 10 to 12 oz. Will service Remington models 700, 40X, Model 7, XR-100 and the rear grip XP-100 pistol.

#RB-LV-1



Remington Trigger ERV-3

Excellent varmint / target trigger. 4 oz. to 20 oz. Factory adjusted to break at 5 to 7 oz. Will service Remington models 700, 40X, Model 7, XR-100 and the rear grip XP-100 pistol

#RB-ERV-3



Ruger Trigger RU-MK II

M77 MK II Centerfires with 3 Position Safety
Fits Current Production M77 MK II - and the new .204 Ruger

Right or Left Hand Installation

Weight of Pull: 14 oz. to 2.5 lbs.

#RB-RU-MK2



Winchester Trigger - Model 70 Centerfires

For the model 70 centerfires - pre or post 1964

Also fits all FN bolt action rifles, commercial, law enforcement and military

#RB-WIN-1



Savage Trigger SAV-2

Long & Short

• Early & Late

• Left & Right Hand

Models: 10, 11, 12, 110, 16, 111, 112, 114 & 116

Will replace standard trigger or AccuTrigger. Also fits Savage/Stevens Model 200

Weight of Pull: 4 oz. to 3 lbs.

#RB-SAV-2



Marlin Trigger MAR-1

Pre-2004 Marlin Rimfire

All bolt action .22's, .22 Magnums & New .17's

Manufactured before 2004

Models: 15, 25, 782, 783, 880, 882, 883, 17 V, 17 VS & 2000

Weight of Pull: 1 lb. to 2 lbs

#RB-MAR-1



Remington Extended Range Varmint Trigger with Safety

For the model 7, 700, 40X.

Weight of Pull: 4 oz. to 20 oz.

#RB-ERV-3K

Ruger Trigger - M77 MK II

Varmint/Target Rifles

Replaces 2 Stage Adjustable Trigger

Weight of Pull: 10oz. to 3 lbs.

#RB-RU-VT



Savage SAV-RAT

Savage Rimfire Replaces AccuTrigger

Models: Mark I & II 93 & 40 .22's & .17's

Weight of Pull: 1.25 lbs. to 4 lbs

#RB-SAV-RAT



Savage SAV-R

Savage Rimfire Rifles &

"Striker" Pistols Models: 501,

502, & 503, Mark I & II, Model

93 .22's & .22 Magnum - New

.17 HMR

Weight of Pull: 10 oz. to 1.5 lbs.

#RB-SAV-R



Buffer Technologies Recoil Buffer

Each carefully designed buffer is made from a polyurethane with specific shock-absorbing properties. When it is placed between the bolt and what it slams against at the extreme range of its travel, the buffer acts as a gentle cushion. Without the buffer, the bolt is driven backwards to make direct violent contact with another piece of steel. In time, this pounding takes its toll. The gun becomes less accurate and the action becomes dangerously loose.



- #BUFT-AK1** AK/Valmet/Gailli Recoil Buffer
- #BUFT-AR15** AR-15 Recoil Buffer
- #BUFT-BER1** Beretta 92/96 Recoil Buffer
- #BUFT-BH1** Browning Hi-Power Recoil Buffer
- #BUFT-45A** Colt 1911 & Clones Recoil Buffer
- #BUFT-CZ1** CZ-75, 85 Recoil Buffer
- #BUFT-FN2** FN/FAL Recoil Buffer
- #BUFT-GK1** Glock Recoil Buffers
- #BUFT-HK1** HK 91/93 Recoil Buffers
- #BUFT-M1A** M1A / M14 Recoil Buffer
- #BUFT-RM14** MINI-14/30 Recoil Buffer
- #BUFT-R1022** Ruger 10/22 Bolt Buffer
- #BUFT-SKS1** SKS Recoil Buffer





Grip Pod

Hand grip instantly opens to bipod with press of button
GPA-000-GP1 Black, Tactical with Steel reinforced legs
GPA-000-GP3 Black, Tactical with Steel reinforced legs
GPA-000-LE Black, LE Version
GPA-000-LET Tan, LE Version



Double Light Rail

#GPA-000-LR2 Black
 #GPA-000-LR2T Tan



Single Light Rail

#GPA-000-LR1 Black
 #GPA-000-LR1T Tan



Retracted Position



Extended Position



Tri-Tech TTT M4 Grip

The TTT M4 Fighting Grip is manufactured to provide the end-user with the highest quality foldable weapon's forearm grip in the operational field today. Military and Law Enforcement operators are demanding a folding grip that permits them to "get small" from cover by quickly folding the grip parallel to the weapon's forearm while maintaining the natural feel of the forearm.

#TRI-MFM4-FG-BLK



Magpul RVG Rail Vertical Grip

Designed for use with milspec 1913 Picatinny rail hand guards, the RVG is a basic, light weight, cost-effective vertical fore grip. Shape is ergonomically designed for use as a traditional vertical grip.

#MAG-413-BLK

Magpul MVG MOE Vertical Grip

Designed for use with MOE and ACR™ (Adaptive Combat Rifle) Hand Guards, the MVG is a basic, light weight, cost-effective vertical fore grip that attaches directly to these hand guards without any rail needed. Shape is ergonomically designed for use as a traditional vertical grip.

#MAG-412-BLK



Accu-Shot BT27 - Folding Vertical Fore Grip

Accu-Shot Folding Vertical Fore Grip using the base and mechanism from our Precision Rail Monopod (PRM), adding a non-moving 3" handle that is knurled with two flats machined into opposing sides where the Buna O-Rings will secure light switches and/or lunch money or both.

Unscrewing the bottom will reveal a storage compartment for a single 123 battery and placing a battery in there positive side (+) towards the relieved cap will insure it won't be drained.

#AS-BT27

Weaver Rail Mount Vertical Grips

Enjoy improved weapon control and heat management with Weaver's new Rail Mount Vertical Grips. Molded of high performance fiberglass-reinforced polymer, these vert grips feature redundant clamp screws for secure, reliable mounting and an adjustable fit to compensate for out-of-spec rails. The grip's o-ring sealed storage compartment is ideal for tools, batteries or spare parts while the two different caps (included) allow for custom length. Made in the USA.

##105-BK-71VG00-BK Black
 ##105-BK-71VG00-OD Olive Drab
 ##105-BK-71VG00-DK Flat Dark Earth



TAPCO Intrafuse Vertical Grip, Short

A shorter version of our highly regarded Intrafuse Standard Vertical Grip. This grip incorporates the same rugged durability, comfort and control in a more compact 3.125" package. Even in its reduced length it still retains storage capacity for (1) 123A battery.

#STT-STK90202-BLK Black
 #STT-STK90202-DE Dark Earth
 #STT-STK90202-OD Olive Drab



TAPCO Intrafuse Vertical Grip

Designed with direct input from military and law enforcement, the TAPCO Vertical Grip provides the shooter with increased weapon control and additional battery storage.

#STT-STK90201-BLK Black
 #STT-STK90201-DE Dark Earth
 #STT-STK90201-OD Olive Drab

TAPCO Intrafuse Vertical Grip Bipod

#STT-BIP90201 Black



ERGO SWITCHMAX XPRESS Lever Vertical Forward Grip

5" length, Black, Internal storage for 123-type batteries
 #119-EG-4272-BK



ERGO POP Bottle Vertical Forward Grip

#119-EG-4253-BK



ATI Forend Pistol Grip

- 5 Positions
- Fits Any Standard Picatinny Rail

#118-ATI-FPG-0100-B



A.R.M.S. #23

Detach Throw Lever
 Pistol Grip
 #ARMS-23



Accu-Shot

The Accu-Shot precision monopod is designed, engineered and built for shooters who demand a high degree of accuracy to meet the challenge of accurately sighting a rifle from either the bench or in the field. Used with a bipod from a stationary surface, Accu-Shot provides an adjustable 3-point platform to your setup, stabilizing your rifle for precise vertical adjustment. By simply rotating the Accu-Shot monopod's soft-touch actuator knob, approximately 100 inches of elevation adjustment at a distance of 100 yards is available.

Accu-Shot Precision Monopod with Quick Knob Option

This unit used with a bipod, attaches to your rifle's rear sling stud, providing repeatable elevation adjustments. One piece unit constructed from machined T6061 Hard anodized Aluminum with Grade 8 fasteners and comes ready to attach to your rifle using an Uncle Mike's Swivel. The leg folds up and retracts, allowing the concurrent use of your sling. No tools required.

- #AS-BT01-QK BT01, Range of 3.4 – 4.5"
- #AS-BT04-QK BT04, Locking version, range of 3.65 – 4.75"
- #AS-BT05-QK BT05, Locking version, range of 4.75 – 5.85"



PRM Standard with Quick Knob Option

The Precision Rail Monopod (PRM) was inspired by the Magpul Precision Rifle Stock (PRS) and has several other applications where a Picatinny Rail is found, including as a folding vertical fore grip. The PRM is our second departure from our original monopod, the first being the ASAI which we borrowed the mechanics from to provide a proven system for the PRM including the push button deployment and retraction feature. Major components are constructed from T6061 Aluminum with a hard anodize finish, internal components made from alloy steels, heat treated to Rockwell 52 for long lasting strength and durability. The leg folds up and retracts out of the way when not needed. Black only.

- #AS-BT12-QK BT12, Range of 3.4 – 4.5"
- #AS-BT13-QK BT13, Range of 4.5 - 5.85"



BT03, M1-A/AR-15 Sling Stud Accessory

Replaces rear M1-A/AR-15 fixed sling loops with a common sling stud. This is necessary for attaching the Accu-Shot to the M1-A, SR and AR family of rifles. Simple installation requires a Screwdriver. Made of steel. Black only. Made in the U.S.A.

#AS-BT03



BT08 - ASAI (Accu-Shot Accuracy International) Monopod

The patented Accu-Shot Accuracy International (ASAI) monopod for the Accuracy International AE, AW and AICS systems. Major components constructed from alloy steels, heat treated to Rockwell 52 for long lasting strength and durability. The ASAI is attached via an application specific nut without modification to the stock and is deployed and retracted with the press of a button. The same actuator knob with steel on steel threads and locking feature found on the BT04 is utilized on the ASAI. The leg folds up and retracts out of the way when not in use. This unit allows a range of travel of approximately 1.05" or elevation adjustments between 3.45 - 4.5" (measured from center of lower Butt-stock bolt clearance hole).

#AS-BT08-QK BT08, Range of 3.4 – 4.5"

BT15 3.35" 1913 Rail

The BT15 3.35" 1913 Rail will accommodate hole patterns with a center to center spacing of 1.30 to 2.25" with a relieved base to accommodate curved surfaces. A standard sling stud can be used as one fastener or two button head machine screws can be used to attach this rail to the forearm of standard rifle stocks. The BT15 can also be attached to a horizontal surface on the butt section to attach our BR12 or BT13 Precision Rail Monopods.

#AS-BT15



Mono Pod Rail adaptor for McMillan Stocks



- Short Rail with Picatinny Top With Knob Attachment**
#LLR-71-SRK-PICR
- Short Rail Build Your Own Platform with Knob Attachment**
#LLR-71-SRK-BYOP
- Short Rail with Sling Stud Knob Attachment**
#LLR-71-SRK-PICR

Harris Bipods

Harris Bipods clamp to any quick detachable sling swivel stud. They have strong recoil springs to prevent damage to the stock and maintain point of impact. Harris Bipods Legs are adjustable for height. Manufactured with heat treated steel and hard alloys with a black anodized finish.

MSP #	HARRIS'S #	SERIS S	SERIES 1A2	SERIES B	SERIES M	LENGTH
HBP-SBR-000	BR*	X		X		6-9"
HBP-1A2-BR0	BR*		X	X		6-9"
HBP-SBR-M00	BRM*	X			X	6-9"
HBP-1A2-BRM	BRM*		X		X	6-9"
HBP-SL0-000	L	X		X		9-13"
HBP-1A2-L00	L		X	X		9-13"
HBP-SLM-000	LM	X			X	9-13"
HBP-1A2-LM0	LM		X		X	9-13"
HBP-S25-000	25	X		X		12-25"
HBP-1A2-250	25		X	X		12-25"
HBP-S25-C00	25C	X		X		13.5-27"
HBP-1A2-25C	25C		X	X		13.5-27"
HBP-1A2-H00	H		X	X		13.5-23"

To Use this Identifier to Select Your Bipod:
 Note: Bench Rest Items are marked with "*" in Harris Column 2.
 1 - Select Rotating or Non-Rotating (S or 1A2, Column 3 or 4)
 2 - Select Leg Notch or Smooth (M or B, Column 5 or 6)
 3 - Select Length from Column 7.
 4 - To order selected item, use MSP# from Column 1.
 5 - Good Shooting!

SERIES S = ROTATE SIDE TO SIDE (CANT)
 SERIES 1A2= NON ROTATING
 SERIES M= LEG NOTCH - 1 INCH INTERVALS
 SERIES B= BASIC (SMOOTH) NON LEG NOTCH
 * BENCH REST MODEL



The Harris Bipods are quick detachable and clamp to the Q.D. stud of any rifle. We offer adapters for those rifles that do not have a factory installed Q.D. studs. Carrying with a sling or shooting off-hand is not impeded by the Bipod



HB2 - Flange Nut

Allows mounting of stud on hollow fore-ends
#HBP-ADP-002

HB2A - Round Head Flange Nut

Allows mounting of Plastic fore-ends
#HBP-ADP-02A

HB2R - Flange Nut

Has radiused flange for mounting to wood fore-ends under magazines or gas tubes
#HBP-ADP-02R

HB3 - Adapter

For Remington Models 4, 74, 7400
#HBP-ADP-003

HB4 - Universal Adapter

Requires two inches of uncluttered barrel for mounting. Fit barrels from .550 diameter to .812
#HBP-ADP-004

HB5 - Stud

Fits Colt AR-15/M16 without alteration. Detachable Swivel Included
#HBP-ADP-005

HB6 - Stud

For European Size Rails (3/8" across rail slot)
#HBP-ADP-006

HB6A - Stud

For American Size Rails (5/16" across rail slot)
#HBP-ADP-06A

HB7A - Spacer

Rubber spacer may allow mounting of Bipods on thin fore-ends.
#HBP-ADP-07A

HB8 - Stud

For Remington XP100 plastic stocks. For models BR, L, LM, & BRM Bipods. (Requires drilling)
#HBP-ADP-008

HB9 - Adapter

For Flat fore-ends
#HBP-ADP-009

HB14 - Bipod Adapter

For Ruger Mini-14, Mini-30 standard and ranch rifles
#HBP-ADP-014

A.R.M.S. #32 Harris Bipod Adapter

No gunsmithing required, simply remove the adjustment screw assembly and install the A.R.M.S. Throw Lever assembly. Designed to allow the lever to be attached to either side of the bipod, for a light weight low profile attachment.
#ARMS-32

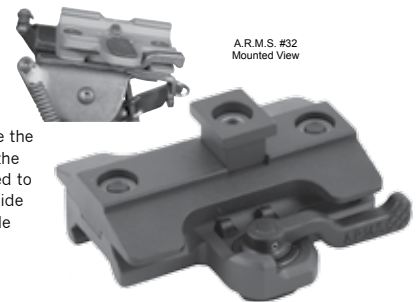

Add-A-Rail System TOP or BOTTOM Tactical Forearm Rail Kit

Use MSP Add-A-Rail System to mount a Grip-Pod or rail mounted bipods to any AR-15 / M-16 handguard.

For use with factory standard, carbine, A-2 and M4 forearms. Designed to allow use of a detachable light, foregrip, or other rail mounted accessories. Can be used on either TOP or BOTTOM side.

- Contents:
 1 Mil.Spec. Rail
 3 Flat Socket Cap Screws
 3 Bottom Well Nuts
 3 Large Bushings
 3 Small Bushings

#LLR-TFR-NR1



Shooters Ridge Bipod Rail Adaptor

Mount your favorite bi-pod to any MIL-STD 1913 Picatinny rail with this new Rail Adaptor from Shooters Ridge. This new rail adaptor provides a solid platform for mounting a bi-pod to any firearm with a Picatinny rail. It's maximum versatility for bi-pod placement options.
105-STR-99502

Shooters Ridge AR-15 Bi-Pod Adaptor

Added accuracy is always desirable in any firearm. Quickly and easily mount a Shooters Ridge Bi-Pod to your Colt AR-15 with this adaptor. Designed for round hand guard models, the AR-15 Bi-Pod Adaptor comes with a detachable swivel included.
#105-STR-40450

Shooters Ridge Swivel Top Picatinny Rail Adaptor

This adaptor attaches to the swivel stud to give standard rifles a MIL-STD 1913 Picatinny Rail option.
#105-STR-99530





Grip Pod

- Hand grip instantly opens to bipod with press of a button.
- GPA-000-GP1** Black, Tactical with Steel reinforced legs
- GPA-000-GP3** Black, Tactical with Steel reinforced legs
- GPA-000-LE** Black, LE Version
- GPA-000-LET** Tan, LE Version



A.R.M.S. #42

VersaPod Bipod Mount
#ARMS-42

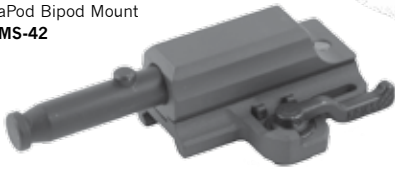

Accu-Shot Atlas Bipod

The Atlas has been tested by professionals and civilians alike, tested in the sands of Iraq and found to not foul, tested in a Red Bull induced shooting session and survived. The V7 Atlas is ready for you.

- Construction from T6061 Aluminum, Type III Hard Anodized black
- Stainless steel springs and fasteners
- UHMW components used for smooth tracking
- 15 degrees +/- of preloaded Pan & Cant
- Preload on Pan and Cant can be tightened by means of the knurled knob
- Picatinny Rail Mount interface by either standard machine screw fastener based clamp or optional ARMS 17S lever mount.
- Non orientated leg positioning use either hand to move leg into any of the four leg positions; legs stowed back, 90 degrees straight down, 45 degrees forward and stowed forward.



- #AS-BT10 Picatinny Rail Mount
- #AS-BT10-LW17 QR lever mount

ATI Universal Featherweight Bipod

Customer assembly required to determine Swivel or Non-Swivel Configuration or AR-15 Configuration. Push "Snap-N-Lock" Button to Fold Legs Forward, Rearward or Downward.

Fits: Any Firearm with a Sling Swivel Stud and AR-15 Types
118-ATI-BIP0300-B



Shooters Ridge Universal Bipod

Enjoy the benefits of a steady rest no matter what firearm you take afield. The new Shooters Ridge Universal Bi-pod features a lightweight molded design that clamps easily onto any standard barrel. With a built-in lock to hold the bi-pod in a closed position for carrying, the Universal Bi-pod is a great way to ensure your next shot is right on target.

#105-STR-10251



Shooters Ridge Bi-Pods

Shooters Ridge Adjustable Bi-Pods provide Rock Steady® assurance for precise shot placement. This compact and lightweight line of bi-pods offers a variety of both pivot and standard models that easily attach to the sling swivel stud. The new 14 1/2" · 29 1/4" standard and pivot bi-pods represent the tallest option available from Shooters Ridge and expand an already existing full line of length options.

- #105-STR-40854 Adjustable from 6"-9"
- #105-STR-40853 Adjustable from 9"-13"
- #105-STR-40852 Adjustable from 13.5"-23"
- #105-STR-40452 Adjustable from 14.5"-29.25"



Shooters Ridge pivoting Bi-Pods

These pivoting bi-pods are designed specifically for hunters who need a steady, portable and versatile rest out in the field. Available in three length options, you're sure to find the right fit for your hunting situation. From sitting or kneeling to prone position, there's a Pivot Bi-Pod for you.

- #105-STR-40855 Adjustable from 6"-9"
- #105-STR-40856 Adjustable from 9"-13"
- #105-STR-40857 Adjustable from 13.5"-23"
- #105-STR-40453 Adjustable from 14.5"-29.25"



Shooters Ridge Deluxe Bi-pod

In the quest to provide hunters with stronger, lighter, quieter bi-pods, Shooters Ridge introduces the Adjustable Deluxe Bi-pod. An innovative mounting system makes this the easiest bi-pod attachment on the market. Up to 30% lighter than conventional bi-pods, the Adjustable Deluxe Bi-pod features twist lock aluminum legs that reduce weight, increase strength and allow stealthy deployment and dual thrust bearings that allow hunters to swivel and cant their gun to stay on moving game. Use with or without a sling.

- #105-STR-40455 Adjustable from 9"-13"
- #105-STR-40457 Adjustable from 13"-23"
- #105-STR-40456 Extra Deluxe Bi-pod Adaptor



Shooters Ridge Deluxe Bi-pod with Picatinny Rail Attachment

Give your AR-style rifle the steady rest and rapid deployment of Shooters Ridge's Deluxe Bi-pod. The new Deluxe Bi-pod with Picatinny Rail Attachment allows shooters to affix the new Deluxe Bi-pod to a picatinny rail—giving AR shooters a whole new advantage in bi-pod technology. Easy on/off combined with lightweight, twist-lock legs makes the Deluxe Bi-pod a stealthy addition to any AR-style rifle.

#105-STR-99555



Stack Sling Delta II

The Stack Sling Delta II has a “double shock impact element” on each end of the sling which is also designed to minimize the weapon’s “shock effect” on the operator. These shock impact elements expand forward and contract backward under the weight of the weapon, thereby absorbing a large percentage of the shock impact created by such activities as jumping or dropping from aircraft or buildings onto the ground. Attached to each SSDI/SSDII™ shock impact element is a Mil Spec HK weapon style lobster hook. The SSDI/SSDII™ weapon hooks can be secured to almost any weapon that has two sling swivels points.

#TRI-MFSSD2



Built-In Shock Elements in Both Straps

Tri-Tech TRAS Tactical Rifle Sling

The TRAS gives the operator the ability to shoot from high angle platforms, aerial platforms, and marine platforms. The TRAS Sling also offers a large margin of safety to the operator in the high angle, aerial, and marine platform environment. The TRAS is possibly one of the only slings in the CQB environment that can furnish the operator with vertical cover by using the primary weapon as a shield and allowing the operator to deploy a secondary weapon immediately.

#TRI-CAR15

CAR 15 Sling

#TRI-MFTRAS11-BK

M-4 side mount swivel, collapsible stock, right hand black

#TRI-MFTRAS10-BK

M-4 side mount swivel, collapsible stock, left hand black

#TRI-MFTRAS02-BK

A-2 under mount swivel, service stock, right hand black

#TRI-MFTRAS07-BK

A-2 under mount swivel, service stock, left hand black



A.R.M.S. SWAN Quick Disconnect Rifle Sling

This unique system was specifically engineered to provide the maneuverability of a single point sling with the stability and performance of a dual point sling. The ability of this one sling to be re-configured on the fly from a dual point to a single point without the need for additional hardware or complex rigging made it ideal for long patrols from the “Z” without compromising performance on the “X”.

#ARMS-SLING-B Black

#ARMS-SLING-T Tan



ATI Sling Kit

- Black Nylon
- Debossed Leather
- Laser Engraved Swivels
- Limited Lifetime Warranty
- FITS: Any firearm with sling swivel studs

118-ATI-A5102260



Magpul ASAP Ambidextrous Sling Attachment Point

The ASAP was designed to give a shooter over 180 degrees range of motion of the sling attachment point and can be used ambidextrously by both left or right handed shooters. This sling mount gives the shooter a tactical advantage allowing a full range of motion and minimizes binding while switching shoulders.

#MAG-500-BLK

Magpul RSA

The RSA provides a forward sling attachment point for the Magpul MS2 and other clip-in sling systems.

#MAG-502-BLK



Magpul MS2 Multi Mission Sling System

Driven by the operational experience of Magpul Dynamics SM instructors, the MS2 Multi-Mission Sling System was designed to give a versatile weapon-retention solution for a multitude of tactical environments and missions. As a standalone product, the rapidly-convertible MS2 allows an operator to leverage the maneuverability of Single-Point® attachment for direct-action, or two-point attachment for stability. Single-hand adjustments, quick-detach lanyard and positive-locking metal hardware provide flexibility and durability in a truly adaptable sling system.

#MAG-503-BLK

Black

#MAG-503-DKEAR

Dark Earth



Cross Tac AR-15 Ambi Single-Point Sling Connector

Minimal profile sling adapter plate provides secure, ambidextrous attachment for single-point tactical slings on carbines or converted shotguns with M4 collapsible buttstocks.

#122-CT-135020

Weaver AR-15 Ambi Sling Adaptor

Quickly and easily attach an ambidextrous sling mounting point without removing your AR-15’s buffer tube. Weaver’s new AR-15 Ambi Sling Adaptor is a no-gunsmith mount that provides sling points on both sides of the receiver. Compatible with snaphooks, MASH hooks, wire loops and sling webbing (up to 1.5” wide) this sling adaptor excels in any one-, two- or three-point tactical configuration.

#105-BK-71SA01-BK

Weaver Rail Mount Sling Adaptor

Attach your sling anywhere on a Picatinny rail with the new Weaver Rail Mount Sling Adaptor. This new sling adaptor provides multiple sling options/locations and is compatible with snaphooks, MASH hooks, wire loops, push-button swivels, or up to 1.25” wide sling webbing.

#105-BK-71SA00-BK

Weaver Heavy Duty Push Button Sling Swivel

Get your sling into action fast with Weaver’s new Heavy Duty Push Button Sling Swivel. With just a push of a button, you can quickly attach or detach a sling from your weapon. Made from quality material and featuring a durable manganese phosphate finish.

#105-BK-71SS00-BK



GRSC Front Swivels A2 Style
#GRSC-CAR-A



GRSC CAR Stock Sling Adapter
#GRSC-CAR-A-2H

GRSC Front Swivels CAR 15 Ambidextrous
#GRSC-CAR-AMBI



GRSC Rear Sling Adapter
#GRSC-ARA-R-LH Left Hand
#GRSC-ARA-R-RH Right Hand
(Not Shown)

GRSC Bayonet Lug Adapter

Rail on bottom of the adapter allows the mounting of accessories such as a flash light.
#GRSC-ARA-F



GRSC Remington 870 Sling Adapter
#GRSC-870-A

ERGO Sling Swivel and Mount
#119-EG-4293



Uncle Mike's QD Super Sling Swivel with Tri-Lock

- Flawless fit and silent operation.
 - Detach quickly, yet provide positive locking for safety
 - Three-lock system for optimum security against accidental opening
 - 1" and 1 1/4" sizes available
- | | |
|---------------|------------------------------|
| #100-UM-10932 | 1" Loop, Nickel |
| #100-UM-10933 | 1 1/4" Loop, Nickel |
| #100-UM-14023 | 1 1/4" Loop, Stainless Steel |
| #100-UM-14033 | 1 1/4" Loop, Black |



Uncle Mike's Mil-Spec Sling Swivel

- Super-heavy-duty - made to military specifications
 - Dependable under the most demanding conditions
 - Set of two 1" swivels
- #100-UM-14032



Uncle Mike's Remington 870 & 870 Youth Magazine Cap with Swivel

Replacement magazine cap with swivel base, 3/4" wood screw butt-stock swivel base and two super swivels.
#100-UM-18012



Uncle Mike's Remington Model 870 Express Magazine Cap with Swivel

QD REM-870 EXP CAP (with internal mag tube ratchet-type system) Replacement magazine cap with swivel base, 3/4" wood screw butt-stock swivel base and two super swivels.
#100-UM-18002

Uncle Mike's Remington 11-87 Sling Adapter

Uncle Mike's black sling kit allow you to simply install stud in butt-stock, replace magazine cap with new adapter cap, and attach sling with quick detachable swivels provided. The 1" sling adapter comes with sling swivel and stud for the butt-stock and replacement magazine cap with swivel.
#100-UM-18032



Shooters Ridge Sling Lok 1" Swivels for Bolt Action Rifles

#105-STR-10264



Shooters Ridge Sling Lok 1" Swivels for Bolt Actions

#105-STR-10262

Shooters Ridge Sling Lok Swivel for Guns with Pre-mounted studs

#105-STR-10260 1-1/4" Swivel
#105-STR-10261 1" Swivel



Shooters Ridge Sling Lok 1" Swivels for Most Shotguns
#105-STR-10263

Shooters Ridge Picatinny Rail Sling Adaptor

With this Picatinny Sling Adaptor, shooters can affix their sling anywhere on a Picatinny rail. Ideal for AR-style rifles and compatible with any firearm featuring a Picatinny rail, this adaptor from Shooters Ridge increases sling mount options.
#105-STR-99510



ERGO Slide Mount, 3/4 inch
#119-EG-4296

ERGO Slide Mount, 1 1/2 inch
#119-EG-4295



TriTech PCO Lycra Lanyard
Same as the PCO Lanyard with a lycra sleeve.
#TRI-MFPCOMCT-00-BLK Black, Lycra Mesh

100% Made in USA.



TriTech PCO Lanyard
The PCO Lanyard is our Plain Clothes Officer lanyard which is designed for soft clothes wear and concealment. The retention coil is smaller and provides effective retention.
#TRI-MFPCO-00-BLK Black
#TRI-MFPCO-00-GRY Gray
#TRI-MFPCO-00-TAN Tan



TriTech Nylon with Tactical Belt Loop
The TRRL has served duty with the United States Military in the War in Iraq, as well as in the War in Afghanistan, and the Bosnia conflict.
#TRI-TBL-MFTRRL01-BLK Black
#TRI-TBL-MFTRRL04-OD Olive Drab
#TRI-TBL-MFTRRL05-TAN Tan
#TRI-TBL-MFTRRL06-GRY Gray

TriTech TRRL Nylon with Duty Belt Loop

This is the ORIGINAL, designed by former Police SWAT Instructor, Rick Garcia. This TRRL is used by the Military and the Police Special Operation groups all over the world.

- | | |
|-----------------------|------------|
| #TRI-DBL-MFTRRL00-BLK | Black |
| #TRI-DBL-MFTRRL04-OD | Olive Drab |
| #TRI-DBL-MFTRRL05-TAN | Tan |
| #TRI-DBL-MFTRRL06-GRY | Gray |
| #TRI-DBL-MFTRRL07-COY | Coyote |
| #TRI-DBL-MFTRRL08-FOL | Foliage |



Browning

Weigand Combat Browning Buckmark Mount

Lightweight, versatile scope mount easily converts the Browning Buckmark from open sights to scope sights with no permanent modifications required. Simply remove the Browning Buckmark factory sight rail and install with the screws provided. Accepts Weaver-style rings and accessories. 6-1/4" black or silver, matte anodized finish, weighs 1.7 ounces.

- #WCO-BBM-22S Silver
- #WCO-BBM-22B Black

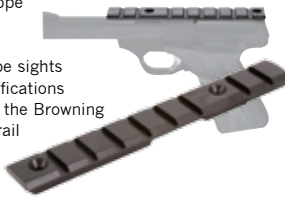

Colt

Weigand Combat Colt Anaconda Python/King Cobra/Trooper Mount

Drilled and Tapped- Matches the hole pattern of Anacondas that come drilled and tapped for scope mounts directly from the factory. This scope mount also fits Pythons. Remove the rear sight and install the scope base with screws provided. Extra large rear lug fits in the sight recess and prevents scope movement caused by recoil.

- #WCC-ANA-MNT-S Silver
- #WCC-ANA-MNT-B Black



Weaver Base for Colt Python, King Cobra, & Trooper MKIII, MKV

Weaver Base, 304 Colt Python, King Cobra, & Trooper MKIII, MKV (not drilled/tapped) - Must remove rear sight to use.

- #WCC-ANA-MNT-S Silver
- #WCC-ANA-MNT-B Black

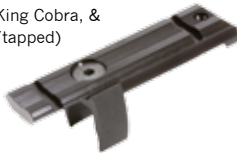

Colt 1911 Scope Mount

The most rugged, most foolproof scope mount ever designed for the 1911 Auto. Attaches to the dust cover; places the scope forward, over the top of the slide for improved balance and faster sight or red dot alignment. Clearance cut for Colt, Enhanced Slides. Includes installation instructions and Allen mounting screws. Installation of this scope mount requires drilling and tapping of frame.

- #WCO-SM3-00S Silver
- #WCO-SM3-00B Black



General Purpose 1911 Mount

A lower cost alternative to the one above.

- #WCO-OGP-SMS Silver
- #WCO-OGP-SMB Black
- #WCO-GPS-NHS Silver



Dan Wesson

Weigand Combat Dan Wesson Large Frame Revolver Mount

Dan Wesson scope mount, attaches directly to the shroud. Uses the factory suggested hole pattern. It requires drilling and tapping three 6-48 holes. Screws and hole location drawing supplied with every mount. Fits all large frame Dan Wesson Revolvers 4-1/2" long.

- WCO-WLF-DTS Silver
- WCO-TLF-DTB Black



Ruger

Weigand Ruger MKI, MKII, MKIII, Government Model Competition 22/45 Mount

Weaver-style installs in seconds if factory drilled and tapped.

- #WCR-RM2-FDS Silver
- #WCR-RM2-FDB Black



Ruger MKI MKII 22/45 Mount

No drill and tapping on newer models. Accepts all Weaver-style rings and accessories.

- #WCR-RM2-SMS Silver
- #WCR-RM2-SMB Black



Weaver Base for Ruger Mark II Pistol, Standard Models

- Must remove rear sight to use. 778-6555 for these items.

- #105-WVR-48641 Black
- #105-WVR-48637 Silver



MSP Ruger MKIII Mil-Spec See Through Base

- Mil-spec dimensions allow the mounting of your choice of scope to the MKIII.
- The front sight is visible with our unique design when no scope is mounted on the MKIII.
- May fit Ruger MKI or MKII. Some gunsmithing required.

- #SLR-M3R-BLS Long Base in Silver
- #SLR-M3R-BLB Long Base in Black
- #SLR-M3R-BSS Short Base in Silver
- #SLR-M3R-BSB Short Base in Black



Weaver Ruger Blackhawk & Super Blackhawk Mount

Weaver 48638: Weaver Base, 301 Ruger Blackhawk & Super Blackhawk - Must remove rear sight to use. - Base listed will NOT fit the 50th Anniversary Commemorative Revolver. #105-WVR-48638 Black #105-WVR-48635 Silver



Weigand Ruger Redhawk Mount

Also Fits Blackhawk & Super Blackhawk and GP-100 Drill & Tapping required.

- #WCR-RAS-WMS Silver
- #WCR-RAS-WMB Black



Weigand Ruger Redhawk Mount

No drill and tap Mount for 6" or 7.5" barrel revolvers. Accepts all Weaver style rings and accessories. 8" long, available in black or silver, matte anodized finish, weighs 3.1 ounces.

- #WCR-RH55ND-B Black 5.5" or 6" barrel revolvers
- #WCR-RH55ND-S Silver 5.5" or 6" barrel revolvers
- #WCR-RRH75-NDB Black 7.5" barrel revolvers
- #WCR-RRH75-NDS Silver 7.5" barrel revolvers



Weaver Ruger Redhawk Mount

Must remove rear sight to use. #05-WVR-48648 Silver

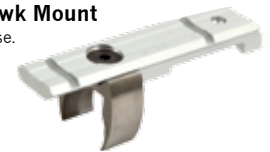

Weigand Ruger Redhawk Hunter Mount

Also Fits Blackhawk Hunter and Bisley Hunter This is a no drill and tap scope mount, Weaver Style.

- #WCR-RRH-NGS Silver
- #WCR-RRH-NGB Black



MSP Ruger MKIII Front Sight Base

Front sight base for mounting a M-65 front sight. #SLR-M3F-M65

MSP Ruger 10/22 Fiber Optic Front Sight

The only 1022 fiber optic sight using industry standard fiber optic that can be changed by the user in seconds! #LLR-1022-FOS

Lightlink for Colt 1911

Tactical Light Rail #SLR-CII-SIL Silver #SLR-CII-BLK Black



Weigand Ruger Super Redhawk Mount

In .480 Ruger and .454 Casull. Weaver style Scope Mount. (for the .480 Ruger and .454)

#WCR-SRH-454 Black



Weigand Ruger Super Redhawk Mount

Weaver style. No drill and tapping. Fits .44 Magnum Only.

#WCR-SRH-44M Silver



Weaver Ruger Security Six Mount

- Must remove rear sight to use.

#105-WVR-48640 Black



Weigand Ruger Single Six Mount

No drill and tap Weaver style scope mount for the Single Six. Accepts all Weaver style rings and accessories.

Now tested with the .17 HRM Single Six.

#WCR-RSS-WMS Silver

#WCR-RSS-WMB Black



S&W

Weigand Smith & Wesson Mount

Also fits the Smith & Wesson.500 X Frame. Fits K, L, N and X frame revolvers that come drilled and tapped from the factory. Top straps on older S&W revolvers can be easily drilled and tapped for this scope mount.

#WCS-SWH-PMS Silver

#WCS-SWH-PMB Black

#WCS-SSW-HPM Stainless Steel



Weigand Smith & Wesson Model 41 Mount

This scope mount fits the newest generation of this Smith Wesson target quality .22 pistol drilled and tapped from the factory.

#WCS-SMW-41B Black



Taurus

Weigand Taurus Scope Mount

Redesigned to fit the Raging Bull .454 Casull. Requires drilling and tapping two, 6-40 holes in top strap. Extra large recoil lug prevents scope movement even on magnum calibers.

#WCT-AUR-DTS Silver

#WCT-AUR-DTB Black

Newer revolvers manufactured after 11-01-00:

#WCT-AUR-OS1 Silver

#WCT-AUR-OB1 Black



Weigand Taurus Tracker .17 and .22 Mount

Fits .17, .22 Caliber Taurus Tracker Revolver. This mount will not fit the TRACKER Model 17C

#WCT-TRACKER17 Black

GHOST Connector for Glocks

The patented Trigger Control Tab (TCT) triggers with this feature are called trigger control connectors. Because we invented and patented this feature it is only available on Ghost Inc. Trigger control connectors the Rocket & Tactical. The TCT works by eliminating over-travel, that extra trigger movement after the pistol fires. This shortens the total length of trigger pull and reset enabling you to shoot faster and better.



GHOST Rocket 3.5 lb Connector

For those who demand to be a lead director and Ghost Maker. This is the finest trigger control connector for all shooting activities including law enforcement & self defense. Notes: Requires Minor Fitting.

#113-GHO-2105-A-1 3.5 lb Trigger Connector for all Glocks

#113-GHO-2105-A2R 3.5 lb Trigger Connector for Ruger SR9



GHOST Ultimate 3.5 lb Connector

Highly polished for the smoothest drop-in 3.5 lb trigger pull possible and incorporates debris channels which makes the Ultimate smooth and self cleaning. These features along with pre-polishing gives you the Ultimate in drop-in light smooth 3.5 lb trigger pulls. Notes: Drop-in no Fitting.

#113-GHO-2105-E-4 3.5 lb Trigger Connector for all Glocks

#113-GHO-2105-E2R 3.5 lb Trigger Connector for Ruger SR9



GHOST Standard 3.5 lb Connector

3.5 LB precision connector is designed & manufactured to exacting tolerances and is polished to ensure the smoothest trigger function possible. Ghost's 3.5 lb connector gives you a slightly shorter and crisper trigger break with a positive reset. Notes: Drop-in no Fitting.

#113-GHO-2105-B-0 3.5 lb Trigger Connector for all Glocks



GHOST Ranger 4.5 lb Connector

Ideal for those who demand the finest drop-in trigger connector for self defense. The GHOST RANGER is the one Ghost family of trigger connectors that makes your glock more reliable. Notes: Drop-in no Fitting.

#113-GHO-2105-F-1 4.5 lb Trigger Connector for all Glocks



GHOST Tactical 5.0 lb Connector

Ideal for those who demand the finest self defense trigger control connector for all shooting activities including law enforcement & self defense. The GHOST TACTICAL 5.0 lb is the one Ghost family of trigger connectors that makes your Glock more accurate and more reliable by eliminating over-travel and the self cleaning holes. Notes: Drop-in no Fitting.

#113-GHO-2105-D-4 5.0 lb Trigger Connector for all Glocks

#113-GHO-2105-D2R 5.0 lb Trigger Connector for Ruger SR9



GHOST LO-PRO Magazine Release

Gives you a rapid magazine release to insure faster reloads with a very low profile.

#113-GHO-LOWPRO



GHOST X-Mag Release

Designed so that you can drop a magazine without changing your firing grip and so you do not have to modify your Glock's frame.

#113-GHO-EMR2200



Ghost Armorer Tool Kit for Glocks

2.5 mm punch with our own orange armorer's plate. This is all you need to disassemble and/or diagnose any and all Glock problems. Great for installing all our trigger products especially the trigger control connectors.

#113-GHO-AKT



Ghost Maritime/Marine Spring Cups for Glocks

Enable your Glock pistol to shoot underwater and under hostile environmental conditions. Notes: Drop-in no Fitting.

#113-GHO-MSC



GHOST Grip Plug Medium & Large Frame Glocks

Designed to keep dirt and debris out of the action of your Glock also serves as a magazine funnel to aid in reloading and prevents the butt of the Glock from ripping through your shirt. Notes: Drop-in no Fitting.

#113-GHO-GPM



Samson SPDTool - Sig Sauer Pistols Tool

The SPDTool Model S is a Pocket-sized field disassembly tool for many models of Sig Sauer™ Pistols.

- Removal of slotted grip screws (bit is replaceable with any standard 1/4" hex-drive bit)
- Magazine catch and support plate removal and installation
- Mainspring removal (old style and 2-piece assemblies)
- Magazine disassembly (10 round and 15 round)
- Removal and installation alignment of pivot pins
- Removal and installation of springs

#SMC-SPD-Tool



Sightlink Signature Series Pistol Sights

Sightlink now adds Signature Series pistol sights to complete its winning rifle and shotgun fiber optic sight line-up. Sightlink fiber-optic sights are used by winning shooters Emanuel Bragg (two time USPSA Gold Team World Shoot winner) and Ted Puente (USPSA Limited Pistol Nationals winner & two time winner of USPSA Limited 3-Gun Nationals) — shouldn't you be using the best, too?

The foundation for the successful use of iron rifle or pistol sights is a front sight that is in sharp focus. The rear sight and the target can be out of focus, but the front sight must be crisp and clear. If not, the shot will not be successful.

Sightlink fiber-optic sights allow the eye to easily and quickly shift from the task of acquiring a distant target to rapidly focusing on the front sight — instantly improving both accuracy and speed. Available in popular colors, Sightlink fiber-optic rods are intended to be changed at the range in seconds.

Signature Series sights are available in three widths to match your shooting style and your rear sight. Standard width sights are .120" wide and utilize a .060" (1.5mm) fiber-optic rod. Match width sights are .095" wide and utilize a .040" (1mm) fiber-optic rod and Ultramatch width sights are .070" wide and use a .030" (.75mm) fiber-optic rod.

Signature Series sights are also available in multiple heights, permitting you to tailor your sights to unique aspects of your weapon and ammunition combination. "0" Sights are standard height. "+1" Sights are shorter, but will move the point of impact up. Use "+1" sights when your weapon shoots too low using standard sights. "-1" Sights are taller, but will move the point of impact down. Use "-1" sights when the weapon shoots too high using standard sights.

Signature Series pistol sights are available for most popular handgun dovetails including Heine, Novak, XD, Sig, Para, CZ, S&W M&P, and the Glock mounting system. Check your existing front sight height before ordering, and remember that changing rear sights may change front sight height requirements.



Front Sight	Standard +1 Height 060 Rod	Standard 0 Height 060 Rod	Standard -1 Height 060 Rod	Match +1 Height 040 Rod	Match 0 Height 040 Rod	Match -1 Height 040 Rod	Ultramatch +1 Height 030 Rod	Ultramatch 0 Height 030 Rod	Ultramatch -1 Height 030 Rod
Heinie	FOS-PFS-S165	FOS-PFS-S180	FOS-PFS-S200	FOS-PFS-M165	FOS-PFS-M180	FOS-PFS-M200	FOS-PFS-U165	FOS-PFS-U180	FOS-PFS-U200
Novak	FOS-PFN-S165	FOS-PFN-S180	FOS-PFN-S200	FOS-PFN-M165	FOS-PFN-M180	FOS-PFN-M200	FOS-PFN-U165	FOS-PFN-U180	FOS-PFN-U200
M&P	FOS-PFM-S160	FOS-PFM-S175	FOS-PFM-S190	FOS-PFM-M160	FOS-PFM-M175	FOS-PFM-M190	FOS-PFM-U160	FOS-PFM-U175	FOS-PFM-U190
Glock	FOS-PFG-S155	FOS-PFG-S165	FOS-PFG-S175	FOS-PFG-M155	FOS-PFG-M165	FOS-PFG-M175	FOS-PFG-U155	FOS-PFG-U165	FOS-PFG-U175
XD/SIG	FOS-PFX-S150	FOS-PFX-S165	FOS-PFX-S180	FOS-PFX-M150	FOS-PFX-M165	FOS-PFX-M180	FOS-PFX-U150	FOS-PFX-U165	FOS-PFX-U180
Para	FOS-PFP-S165	FOS-PFP-S180	FOS-PFP-S200	FOS-PFP-M200	FOS-PFP-M200	FOS-PFP-M200	FOS-PFP-U200	FOS-PFP-U200	FOS-PFP-U200
CZ75/BHP	FOS-PFB-S135	FOS-PFB-S150	FOS-PFB-S165	FOS-PFB-M135	FOS-PFB-M150	FOS-PFB-M165	FOS-PFB-U135	FOS-PFB-U150	FOS-PFB-U165
CZ SP01	FOS-PFZ-S140	FOS-PFZ-S150	FOS-PFZ-S160	FOS-PFZ-M140	FOS-PFZ-M150	FOS-PFZ-M160	FOS-PFZ-U140	FOS-PFZ-U150	FOS-PFZ-U160

Notes:
 1. Standard width sights are .120" wide.
 2. Match width sights are .095" wide.
 3. Ultramatch width sights are .070" wide.
 4. "0" Sights are standard height.
 5. "+1" Sights are shorter, but will move the point of impact up. Use "+1" sights when the weapon shoots too low using standard sights.
 6. "-1" Sights are taller, but will move the point of impact down. Use "-1" sights when the weapon shoots too high using standard sights.
 7. Heinie cuts are .300x.060x60 degree dovetail — commonly found on STI/SV factory slides
 8. Novak sights use a .330x.075x65 degree dovetail
 Check your existing sight height before ordering. Change of rear sights will effect front sight height requirements.



Endorsed by Pro Shooters
 Ted Puente and Emanuel "Manny" Bragg

Buffer Tech Glock MagWell

Glock MagWell – The Glock MagWell is a must have for all shooters, providing fast smooth reloading without fumbling around. The Glock MagWell will install on any full-sized 9mm, .40, .45 GAP, and .357 Sig Glock without any modification.

#BUFT-PGMW



Magpul Speedplate

Similar in concept to the Magpul Ranger Plate for AR15/M16 magazines, the Speedplate allows for rapid magazine extraction and positive handling. Protects the base of magazine from impact. The Speedplate replaces factory floorplates on GLOCK 9mm and .40S&W pistol magazines.

#MAG-230-BLK - GLOCK 9mm/.40S&W, 3 Pack, Black



UpLULA Univ. Pistol Mag. Loader

The amazing speed and convenience of our original LULA Speed Loader and Unloader is now available to handgunners. One size fits virtually all 9mm, 10mm, .357-, .40-, and .45-caliber mags - both single and double stack from all manufacturers.

#100-BC-24222

9mm - .45 CAL UPLULA

#100-BC-24223

.22 - .380 CAL BABY UPLULA



Rear Sight	Standard 0 Height 030 Rod	Standard -1 Height 030 Rod
M&P	FOS-PRM-245	-NA-
Glock	FOS-PRG-S255	FOS-PRG-S275
XD/SIG	FOS-PRX-S170	-NA-
CZ SP01	FOS-PRB-S220	-NA-



Glock Front Night Sight

Green tritium
Item # **Models/ Color**
#AGS-GLO-112 All Model Glock .165" height
 .140" wide, Green

Glock Classic Style Night Sight

Front & Rear 3 Dot, Bright white outlines Item
Item # **Models/ Color**
#AGS-GLU-113 17,19, 22, 23, 24, 26, 27, 33, 34, 35,
 37, 38, 39, Green/Green
#AGS-GLU-115 17,19, 22, 23, 24, 26, 27, 34, 35, 37,
 38, 39, Green/Yellow
#AGS-GLU-119 20, 21, 29, 30, 31, 32, 33, 36,
 Green/Green
#AGS-GLU-121 20, 21, 29, 30, 31, 32, 33, 36,
 Green/Yellow

Glock Operator Style Night Sight

Front & Rear 3 Dot Sight, Thin (.125") tritium front w/ white
 outline, tritium rear (NO outlines),
 Quick front sight acquisition
Item # **Models/ Color**
#AGS-GLO-146 17,19, 22, 23, 24, 26, 27, 33, 34, 35,
 37, 38, 39, Green/Green
#AGS-GLU-148 20, 21, 29, 30, 31, 32, 33, 36,
 Green/Green

Glock Pro Series Night Sight

Front & Rear 3 Dot Sight, Rear extends to end of slide
 (Increased sight radius), Undercut rear face to reduce glare,
 Extra-wide rear notch (.180"), Smooth low profile design, Also
 available in Operator version (no white outline on rear)
Item # **Models/ Color**
#AGS-GLO-227 17,19, 22, 23, 24, 26, 27, 33, 34, 35,
 37, 38, 39, Green/Green
#AGS-GLO-233 20, 21, 29, 30, 31, 32, 33, 36,
 Green/Green

Glock Ghost Ring Sight

3 Dot, Quick front sight acquisition
Item # **Models/ Color**
#AGS-GLO-125 17,19, 22, 23, 24,26, 27, 33, 34, 35,
 37, 38, 39, Green/Green
#AGS-GLO-126 20, 21, 29, 30, 31, 32, 33, 36
 Green/Green

FN Night Sight

Front & Rear 3 Dot, Green/Green
#AGS-FN-601 FNP 9mm, Green/Green
#AGS-FN-603 FNP .40 Green/Green
#AGS-FN-605 FNP .45 Green/Green

H&K USP Night Sight

Front & Rear 3 Dot, Bowie Tactical Design
#AGS-HK-153 USP Full Size, Green/Green
#AGS-HK-157 USP Compact, Green/Yellow

Sig Sights Night Sight

Front & Rear 3 Dot, Green/Green
#AGS-SIG-161 Fits, 225, 226, 228, 239, 2009

Springfield XD9

3 Dot Night Sight, Green/Green
#AGS-XD-191 Fits all Springfield XD models

Smith & Wesson M&P Night Sight

Front & Rear 3 Dot, Bowie Tactical Design
#AGS-SW-801 Green/Green
#AGS-SW-802 Green/Yellow

AK-47 Night Sight

Green tritium dots, Windage-adjustable rear,
 No modifications to weapon, M6 x .075 thread front
#AGS-AK-715 Front, Fit most AK-47's 1 Dot Green
#AGS-AK-961R Rear Chinese AKS, 2 Dot Green
#AGS-AK-981R Rear 7.62 x 39 Models, 2 Dot Green
#AGS-AK-991R Rear 5.45 x 39 Models, 2 Dot Green

AmeriGlo AR-15 Night Sight

Fits Most Colt and AR-15 clones.
 AmeriGlo sights are machined from US-made bar stock steels
 and assembled using Swiss-made tritium light sources. Ameri-
 Glo sights are used worldwide by law enforcement, military,
 defense-minded free citizens, and recreational shooters.
#AGS-M16-150 Front Sight, Green
#AGS-M16-250 Front & Rear Sight, Green/Green

M14 / M1A Front Night Sight

1 Dot (Green tritium dot)
#AGS-MF-615

Mossberg 590 A1 Night Sight

Front & Rear 3 Dot, Green/Green
#AGS-MB-590 Mossberg 590, Green/Green

Remington Night Sight

Front & Rear 3 Dot, Green/Green
#AGS-REM-301 Fits models: 74, 76, 740, 760, 870,
 1100, 1187, 7400, 7600

SKS Night Sight

#AGS-SKS-717 Front Sight, Green

MGW Sight Installation Tools

#AGS-GTool-2 Glock Rear Sight Tool
#AGS-HKTool-5 HK UPS Sight Tool
#AGS-SIGTool-6 SIG Sight Tool
#AGS-XDTool-10 Springfield XD Front & Rear Sight Tool
#AGS-SWTool-12 S&W M&P Sight Tool

Glock Front Sight Installation Tool

Economy Model
 Tool 3: 3/16" nut driver for front sight installation
 Made of steel. Will perform multiple installations
 1.5" in length
#AGS-GTOOL-3

Glock Front Sight Installation Tool Pro Model

Tool 4: 3/16" nut driver for front sight removal and instal-
 lation. Ideal for gunsmith, armorer. Will last a lifetime
 4" in length
#AGS-GTOOL-4



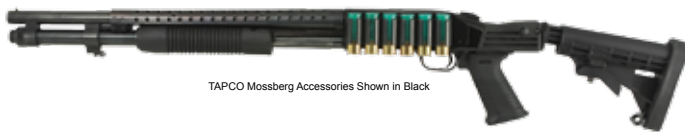

TAPCO Mossberg Accessories Shown in Black

TAPCO Intrafuse Shotgun T6 Stock Set

There is no better home defense weapon than the 12 gauge shotgun. Designed to make the weapon more ergonomic and compact, the TAPCO T6 Shotgun System provides the shooter with a six-position adjustable stock and a SAW-Style pistol grip. For added comfort, the T6 Stock also comes standard with our rubber buttpad. Constructed of high-strength composite, our stock is rugged enough for years of use and comes with a lifetime warranty.

- #STT-STK54160-BLK Black, Intrafuse Mossberg T6 Stock Set
- #STT-STK55160-BLK Black, Intrafuse Remington T6 Stock Set



ATI Top Folding Stock with Pistol Grip

Shotgun functions in open or closed position. Includes rear pistol grip. Quick release button allows stock to lock in folded or unfolded positions. Sling swivel stud included. Ambidexterous. Stock is pre-drilled to accept shell holder. Shotshell Holder sold separately (SH00500).

Stock Fits: 12/20GA Mossberg 500/590, Remington 870, Winchester 1200/ 1300 & Maverick 88

#118-ATI-TFS-0600-B

ATI Shotgun Shotshell Holder

Durable elastomeric polymer 5-shell carrier mounts securely with screws. Quick and easy access to extra 12 GA rounds. Fits: Top Folding Stock or on either side of any full length wood or synthetic stock

#118-ATI-SHO-0500-B



ATI Akita Adjustable Shotgun Stock

Change Length of Pull from 12 3/8" - 14 3/8"

- Adjustable 4 Position Buttstock
- Adjustable Neoprene Cheekrest
- Recoil Reducing Buttpad
- Interchangable Grip Inlays

FITS: All 12/20G (with adaptors) Mossberg 500/590, Remington 870, Winchester 1200/1300, and Maverick 88. Synthetic forends on new Mossberg 500A cannot be replaced because action bars are attached to the forend.

- #118-ATI-AHS0100 ATI Akita Adjustable Shotgun Stock with Forend
- #118-ATI-AHS0200 ATI Akita Adjustable Shotgun Stock Only



ATI Six Position Side Folding Tactical Shotgun Stock & Forend

Give your shotgun a personality of its own! Six Position Collapsible/Side Folding Tactical Shotgun Stock.

- Buttstock Folds to Left Side of Receiver
- Removable/Adjustable Cheekrest
- Non-Slip Removable Rubber Buttpad
- 6" Tube Drop Adaptor for Recoil Comfort
- Three 2" Picatinny Rails
- Textured Pistol Grip
- Lifetime Warranty

FITS: All 12/20G (with adaptors) Mossberg 500/590, Remington 870, Winchester 1200/1300, and Maverick 88. Synthetic forends on new Mossberg 500A cannot be replaced because action bars are attached to the forend.

- #118-ATI-TSG-0100-B Shotgun Stock & Forend
- #118-ATI-TSG-0200-B Shotgun Stock Only



ATI Collapsible Shotgun Stock with Pistol Grip and Forend Package

Stock is made from Matte Black Glass-Filled Nylon

- Collapsible, Six-Position Buttstock with Pistol Grip
- Stock can adjust length of pull from 9 1/4" to 13 1/4"
- Sling Swivel Stud
- Mounting Hardware and Adapters Included

FITS: 12/20GA Mossberg 500/590, Remington 870, Winchester 1200/1300

Note: Synthetic Forends on new Mossberg 500A cannot be replaced because action bars are attached to forend.

#118-ATI-MRF-6200-B



ATI Pistol Grip Buttstock for Remington 1100/11-87 Shotguns

Give Your Shotgun a Personality of Its Own

- Slim Ergonomically Designed Pistol Grip
- Rubber Buttpad
- Sling Swivel Stud
- Uses Factory Stock Bolt
- Non-slip Pebble Grain Grip for Improved Control

Fits: 12 GA Remington 1100/11-87 Shotguns

118-ATI-SPG-0200-B

Tactical Stock with Pistol Grip and Buttpad

Give Your Shotgun a Personality of Its Own

- 6 Position Collapsible Shotgun Buttstock
- Stock Changes Length of Pull From 9 1/4" to 13 3/4"
- Sling Swivel Stud
- Easy Installation
- Scratchproof and Weatherproof

FITS: All 12/20G (with adaptors) Mossberg 500/590, Remington 870, Winchester 1200/1300, and Maverick 88. *Synthetic forends on new Mossberg 500A cannot be replaced because action bars are attached to the forend.

ATI Tactical Shotshell Holder

Five additional 12GA shotshells are easily accessed from the elastomeric polymer Shotshell Holder. Designed for right or left-handed shooters, it is specially engineered for the Advanced Technology, Inc. Tactical AR-15/M-4 Style Buttstock. (MRW4100) Mounting hardware and adapters included.

#118-ATI-SBS-4300



ATI Shotgun Pistol Grip Buttstock & Forend Package

Stock is made from Matte Black Glass-Filled Nylon

- Improves Shooting Accuracy
- Provides a Stronger Grip
- Reduces fatigue when shooting Slugs and Turkey Loads

FITS: 12/20GA Mossberg 500/535/590/835 , Remington 870, Winchester 1200/1300

Note: Synthetic Forends on new Mossberg 500A cannot be replaced because action bars are attached to forend.

#118-ATI-PGB-6100-B



ITT Shot Shock - Shotgun Recoil Buffer

The ITT Enidine Shot Shock™ is a telescoping hydraulic recoil reducing buffer replacing the receiver extension tube, offering easy installation with your stock adapter and collapsible butt stock, designed for virtually all pump-action shotgun and bolt-action rifles regardless of loads/calibers being fired.

- Amazing 70% reduction in felt recoil
- Easy installation with your stock adapter
- Accepts a wide variety of OEM & Aftermarket collapsible butt stocks
- Designed for all pump-action shotguns and bolt-action rifles, regardless of loads, gauge, caliber being fired.

#TT-SP22898ENI

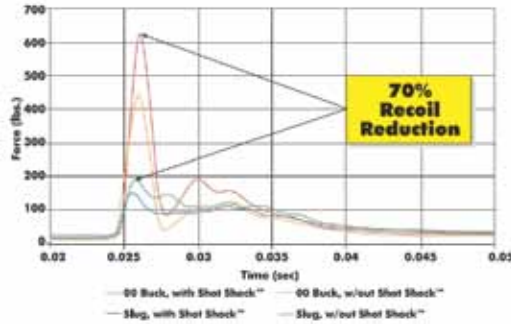

Large Recoil Pads

For Remington 700, Ruger300, M-16 family. Adds .5" to overall length
#RPL-BLK-001



Medium Recoil Pads

(Medium) for Remington 30-06 and Marlins. Adds .5" to overall length.
#RPL-BLK-002

Small Recoil Pads

(Small)
#RPL-BLK-003



ATI Shotgun Pistol Grip Forend

- Ergonomically Designed
- Non-Slip, Double Finger Pebble Grain Grip for Maximum Control and Comfort
- Forend Wrench and Instructions Included
- Easy Removal and Installation

Includes Mounting Hardware Adapter Kit for: Winchester 1200/1300, 12/20 Gauge, Remington 870, 12/20 Gauge, Mossberg 500/535/590/835, 12/20 Gauge, Maverick 88, 12/20 Gauge

Note: Synthetic forends on new Mossberg 500A cannot be replaced. Will Not Fit the Maverick 88

#ATI-SFP0300



ERGO Three Rail Shotgun Forend

T6061 aluminum anodized to mil-spec standards. Each forend comes with LowPro Rail Covers.

- #119-EG-4871 Remington 870 Short, Black
- #119-EG-4870 Remington 870, Black
- #119-EG-4865-SH Mossberg 500/590 Short 5 13/16" tube length, Black
- #119-EG-4865 Mossberg 500/590 Medium 6 15/16" tube length, Black

ATI Shotgun Rear Pistol Grip

- Designed with an Ergonomic, Textured Grip for Maximum Control and Comfort
- Top-Mounted Sling Loop
- AR Style Pistol Grip
- Slimmer Style for Hand Comfort
- Easy Installation

Includes Mounting Hardware Adapter Kit for: Winchester 1200/1300, 12/20 Gauge, Remington 870, 12/20 Gauge, Mossberg 500 /535/590/835, 12/20 Gauge, Maverick 88, 12/20 Gauge

#ATI-SRG0200



ERGO SURESTOP Tactical Rail Hand Stop

Black
#119-EG-4201-SS



ATI Remington 7600 Tactical Buttstock with Pistol Grip

- 6 Position Collapsible Stock
- Stock Adjusts Length of Pull from 9-1/4" to 13-1/4"
- Pebble Grain Grip
- Slim, Ergonomically Designed Pistol Grip for Maximum Control
- Sling Swivel Stud
- Free Buttpad

Fits Remington pump action and semi rifles: 7600, 7615, 760, 7400 and 740 in all calibers.
#118-ATI-REM-7100

ATI Stock Drop Spacer

- Lower the vertical angle of your stock!
- Lower Cheek Position 1/2"
- Improves Shooters Alignment with Front Bead
- Used with ATI's Six-Position Collapsible Stock (MRW4100, MRF6200, MRF6200C)

FITS: ATI Six-Position Collapsible Stock
#118-ATI-MRW4500



PRI Mossberg 590 Base

Mil. Spec rail, milled high strength aluminum construction.
#BMP-ALM-590



PRI Remington 7615P Rail

Top Rail for the Remington 7615, 223 caliber pump rifle.
Mil. Spec rail, milled high strength aluminum construction.
#BRP-AL7-61P



PRI Remington 870 Shotgun Rail

Mil. Spec rail, milled high strength aluminum construction.
Drilling and tapping required.
#BRP-ALM-870



Weaver Tactical Multi-Slot Shotgun Bases

These versatile bases from Weaver help give your gun the tactical edge. Tactical Multi Slot Bases are constructed of tough, lightweight aluminum so they can withstand the most powerful recoil.

- #105-WVR-48333 Multi Slot Mossberg 590
- #105-WVR-48337 Multi Slot Winchester 1300

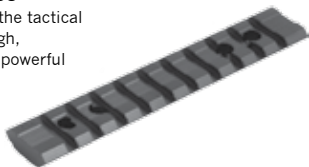

Weaver Converta-Mount System

They let you transform your bird gun into a deer hunting firearm along with the change in seasons. Two thumb screws put your scope on or take it off. Our see-under systems let you use your scope or bead.

- #105-WVR-48870 Rem 870, 1100, 1187 Med Rings
- #105-WVR-48881 See-Under Rem 870, 1100 Low Rings
- #105-WVR-48884 See-Under Mossberg 500/835 Low Rings
- #105-WVR-48883 See-Under Win 1200, 1300 Low Rings



CDM Gear MOD-C Barrel Flashlight Mount

Design Clamp is finally available again in a new design and fit for 1" flashlights. This superior, light weight clamp is small and compact enough to reduce your shotgun profile so it reduces hang ups and snags. The light mount has been moved out a bit for even better light control. Steel threaded inserts means no stripped threads when tightening the clamp down.

#CDM-MOD MOD-C w/ 3 slot rail



CDM Gear BMT - Barrel Magazine Tube Mount

The Barrel Magazine Tube clamp is finally available again in a new design and fit. This stylish, light weight clamp is small and compact enough to reduce your shotgun profile so it reduces hang ups and snags, yet allows the mounting of scope rails at optimal locations. Steel threaded inserts means no stripped threads when tightening the clamp down.

#CDM-BMT-3 BMT w/ 3 slot rail



BMT w/ 3 slot rail and Optional Swivel Set

CDM Gear MT Clamps

Places the light at the optimum location for finger accuated lights, not below the centerline of the shotgun, so you don't have to shift your grip to turn the light on. Steel thread inserts won't "strip out" like aluminum threads in thin walled clamps. Provides a solid "lock up" around the mag tube to mount a light, laser or sling swivel on just about any 1" mag tube.

#CDM-MT MT Clamp w/ 3 slot rail



CDM Gear accessories

- #CDM-3SLOT Extra 3 slot rail
- #CDM-6SLOT Extra 3 slot rail
- #CDM-SWIVEL Sling Swivel Dock PD Sling Swivel



L&M Single Ring Shotgun Magazine Tubes Mount

Precision machined, hard black anodized with a non-reflective finish and supplied with black oxide coated steel mounting screws that resist stripping.

- Hard black anodized to MIL-A 8625F
- Precision machined from aircraft 6061T-6 aluminum
- All MIL-SPEC-1913 rails designed to meet military specifications
- Black oxide coated steel mounting screws resist stripping



- #123-LMS-LM01 1" Tube - Single Ring Mount Tube. Fits Winchester 1300 Defender; Mossberg 590, 500; Remington 870, 1100, 1187; Mariner and others with extended magazine tube
- #123-LMS-LM02 26mm Tube - Single Ring Mount. Fits Benelli, FABARM, and Franchi Spas Magazine Tubes
- #123-LMS-LM03 25mm Tube - Single Ring Mount. Fits Special Mount for Mossberg 590A1 Heavy Millspec Barrel and Ithaca Shotgun Magazine Tubes

L&M Triple Rail Adapter Shotgun Mount

Precision machined, hard black anodized with a non-reflective finish and supplied with black oxide coated steel mounting screws that resist stripping.

- Hard black anodized to MIL-A 8625F
- Precision machined from aircraft 6061T-6 aluminum
- All MIL-SPEC-1913 rails designed to meet military specifications
- Black oxide coated steel mounting screws resist stripping



- #123-LMS-RSM-01 1 in. MIL-SPEC-1913 Triple Rail Adapter. Fits Winchester 1300 Defender & Remington 870, 1100, 1187 Magazine Tubes
- #123-LMS-RSM-025 25mm MIL-SPEC 1913 Rail Adapter. Fits Mossberg and Ithaca Shotgun Magazine Tubes
- #123-LMS-RSM-26 26mm MIL-SPEC 1913 Rail Adapter. Fits Benelli, FABARM, and Franchi Spas Magazine Tubes





The Original Tri-Link Shotgun Sights
Set of three colors included



Pick up your front sight instantly... with the aid of Tri-Link® fiber optics!

- Three beads joined together with either Red, Green, or Amber Fiber Optics to form the brightest sight available.
 - Contains all three colors that can be changed by user.
 - Drill and tapping required.
- #FOS-SST-004**



Sightlink Single Bead Shotgun Sights



(Example of single bead)



- Single bead with either Red, Green, or Amber Fiber Optics. Includes One 2" Piece of Rod. Drill and tapping required.
 - Drill and tapping required.
- #FOS-SSB-03G** Green
#FOS-SSB-03R Red
#FOS-SSB-03A Amber



(Other options)

Mossberg 590 A1 Night Sight

Front & Rear 3 Dot, Green/Green
#AGS-MB-590 Mossberg 590, Green/Green



Remington Night Sight

Front & Rear 3 Dot, Green/Green
#AGS-REM-301 Fits models: 74, 76, 740, 760, 870, 1100, 1187, 7400, 7600



ATI 12 Gauge Shotgun Mag Extension

- Increase Your Round Capacity to 7 or 8 Rounds
- Virtually Indestructible
- Extreme Temperature Glass Reinforced Polymer Injection Molding Over a Steel Connecting Nut

- #STI-A510-1100** 7 Shot Winchester 1200/1300, 12 Gauge
#STI-A510-1110 8 Shot Winchester 1200/1300, 12 Gauge
#STI-SMR0700 7 Shot Remington 870 & 1100/11-87 12 Gauge
#STI-SMR0800 8 Shot Remington 870 & 1100/11-87 12 Gauge



ATI Mag Clamp/ 1" Flashlight Accessory Clamp

Strengthen the connection of the mag extension to barrel. Includes sling swivel stud which is reversible for right or left-handed shooters. May also be used to mount 1" diameter light or laser to barrel.
FITS: All 12GA Shotguns
#18-ATI-SMC-1100



Tri-Link Shotgun Single Bead Sight Gunsmith Pack

- Contains:
- 4 Red beads
 - 4 Amber beads
 - 4 Green beads
 - 1 Piece 2" red rod
 - 1 Piece 2" amber rod
 - 1 Piece 2" green rod
- Drill and tapping required.
#FOS-SSB-001



Tri-Link Shotgun Bead Gunsmith Kit

- Contains:
- 12 Empty beads
 - 1 Piece 3" red rod
 - 1 Piece 3" amber rod
 - 1 Piece 3" green rod
- Drill and tapping required.
#FOS-SSB-002



Tri-Link Armorer's Kit

- Contains:
- 18 Empty beads
 - 1 Piece 6" red rod
 - 1 Piece 6" amber rod
 - 1 Piece 6" green rod
- Drill and tapping required.
#FOS-SST-005



Champion EasyHit Shotgun Sights



- Quickly and safely acquire sight picture
- Fits any ventilated, solid rib or flat surface
- Can be mounted to ported barrels
- Enables shooters to keep both eyes open
- Ensures proper shooting form
- Available in 2.5mm & 3mm diameter fluorescent green

- #105-CHP-45840** Green, 2.5mm · 5" length
#105-CHP-45841 Green, 2.5mm · 2.75" length
#105-CHP-45842 Red, 2.5mm · 5" length
#105-CHP-45843 Red, 2.5mm · 2.75" length
#105-CHP-45844 Green, 3mm · 5" length
#105-CHP-45845 Green, 3mm · 2.75" length
#105-CHP-45846 Red, 3mm · 5" length
#105-CHP-45847 Red, 3mm · 2.75" length

Replacement Fiber Optics...

Sold by the foot.

MSP Fiber Optic Rods		
#FOR-200-RED	.080 Red	(2mm)
#FOR-200-GRE	.080 Green	(2mm)
MSP TRI-LINK and others		
#FOR-060-RED	.060 Red	(1.5mm)
#FOR-060-GRE	.060 Green	(1.5mm)
#FOR-060-AMB	.060 Amber	(1.5mm)
MSP SIGHT-LINK and others		
#FOR-040-RED	.040 Red	(1mm)
#FOR-040-GRE	.040 Green	(1mm)
#FOR-040-AMB	.040 Amber	(1mm)
#FOR-030-RED	.030 Red	(.75mm)
#FOR-030-GRE	.030 Green	(.75mm)
#FOR-030-AMB	.030 Amber	(.75mm)
#FOR-020-RED	.020 Red	(.5mm)
#FOR-020-GRE	.020 Green	(.5mm)
#FOR-020-AMB	.020 Amber	(.5mm)



ATI Shotgun Chrome Heat Shield with Ghost Ring Sights

- Steel Heatshield
 - Elongated Cooling Slots
 - Chrome Finish
- Fits: Most 12 Gauge Pumps, Mossberg 500, Remington 870, Winchester 1200/1300 & Maverick 88
#118-ATI-A5109010 with Ghost Ring Sights
#118-ATI-A5109000 with out Ghost Ring Sights

ATI Marine Heatshield with Ghost Ring Sights

- Steel Heatshield
 - Elongated Cooling Slots
 - Satin Nickel Finish
 - Stainless Steel Hardware
- Every Marine Heatshield includes Mounting Hardware and Adapter Kit which allows installation to: Fits most 12, 16 and 20 Gauge and .410 pump shotgun barrels
#118-ATI-MHS-4800-B

ATI Deluxe Heatshield with Ghost-Ring Sights

- Steel Heatshield
 - Elongated Cooling Slots
 - Matte Black Finish
 - 13-1/2" long
- Note: Heatshield must be "slotted" and ghost ring sights removed when used on scoped rifles. Every Deluxe Heatshield with Ghost Ring Sight includes Mounting Hardware and Adapter Kit
Fits most 12, 16 and 20 Gauge and .410 pump shotgun barrels
#118-ATI-SBS-4600-B





Aimpoint M3 & ML3

When police and armed forces personnel are on duty, they need their equipment to handle just about any situation, any time, anywhere. That's why Aimpoint created the CompM3, a revolutionary sight that offers the highest standard available for sight systems technology.

Aimpoint M3

Night Vision Compatible
 #AIM-11408 2MOA
 #AIM-11403 4MOA

Aimpoint ML3

#AIM-11416 2MOA
 #AIM-11405 4MOA



Aimpoint M2 & ML2

The CompML2 is a specially modified version of our groundbreaking CompC sight and is designed to meet law enforcement and military needs. Can also be used by hunters and sport shooters who demand the best in the field.

Aimpoint M2

Night Vision Compatible
 #AIM-10336 4 MOA

Aimpoint ML2

#AIM-10338 4 MOA

Aimpoint Comp C3

Ideal for scout rifles, bows, carbines and competition pistols
 #AIM-11412 2MOA
 #AIM-11402 4MOA



Aimpoint 9000SC

Ideal for rifles with shorter actions, semi-automatic firearms and magnum handguns.
 #AIM-11417 2MOA
 #AIM-11407 4MOA
 #AIM-11410 4MOA Camo



Aimpoint 9000L

Ideal for big game and sport-shooting rifles with standard or magnum-length action and semi-automatic rifles
 #AIM-11406 4 MOA



A.R.M.S. #22M68

Designed exclusively for the Aimpoint® Comp. ML 1, ML 2 and ML 3 sights. Low standard height allows perfect Red Dot co-witnessing on M16/M4 with A.R.M.S. #38™ Sleeves and S.I.R. without a spacer. A full spacer is required if mounting directly on the flat top rail. Designed exclusively for the Aimpoint Comp. ML 1, ML 2 and ML 3 sights.
 #ARMS-22M68

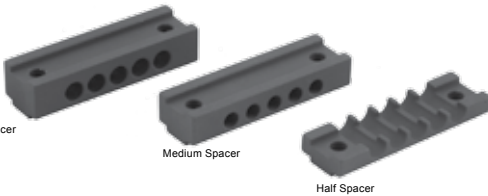

Full Spacer

Medium Spacer

Half Spacer



A.R.M.S. #22M68 EX

Cantilever Spacer
 #ARMS-22M68EX



Aimpoint Ring with #22-M68 EX Cantilever Spacer

For use with A.R.M.S. 22M68 Aimpoint Ring



#LLR-PCW-001

Perfect Co-Witness Spacer, same cheek weld for iron sights and Aimpoint. Allows for precise eye to sight alignment when used in combination with Aimpoint sights on AR-15. Available for A.R.M.S. #17 or #17S or PRI Bases.

A.R.M.S. #22M68 Spacer

#ARMS-22M68SP-5
 #ARMS-22M68M
 #ARMS-22M68SP

Half Spacer - adds .25"
 Medium Spacer - adds .387"
 Full Spacer - adds .5"



PRI 30mm Aimpoint Ring High

Constructed of hard coat anodized aluminum with a matte finish. The top piece is constructed of steel for maximum holding power
 #ROP-004-005 Low, 580."
 #ROP-004-010 High Ring, 1.25"



Aimpoint Wide Rings

#AIM-12244 Low Picatinny
 #AIM-12243 Low Weaver

Aimpoint's QRP Ring

#AIM-12245 Mil-Spec Ring
 #AIM-12246 Weaver Style



Weaver Tactical Aimpoint 30mm Mount

Feature 1/3rd co-witness with Mil-Spec iron sights, aircraft-grade 6061-T6 aluminum and Type III hard coat anodizing.
 #105-WVR-99667

QRP Spacer

with Screws
 #AIM-12227-QRP



A.R.M.S. #16A Aimpoint A2 Carry Handle Mount

The #16A allows for the mounting of the Aimpoint M2/ML2 & other Comp. sights to be mounted directly to the carry handle of the AR-15/M16/M16A1/M16A2/M4. 30mm ring mount. The see through design allows for use of iron sights with the mount in place.
 ARMS-16A



Aimpoint Comp Outer Rubber Cover

#AIM-12226 Dark Earth Brown
 #AIM-12225 Black



Aimpoint-Comp-M4, 2MOA

The Aimpoint CompM4 series of sights are the finest sights that Aimpoint has ever produced. Improvements include improved energy efficiency that provides up to 8 years of continuous use from a single AA battery! The CompM4 sights incorporate an integral mount that eliminates the need for a separate ring, and can be customized with vertical and forward spacers to fit a variety of weapon systems. They can also be used by hunters and sport shooters that need night vision compatibility.

To accommodate our customers, the CompM4 series of sights are available in two versions. The CompM4 offers a high battery compartment, while the CompM4s offers a low battery compartment. In all other aspects, the Aimpoint CompM4 and Aimpoint CompM4s are identical.

#AIM-12172 Aimpoint Comp M4s Low Battery Compartment

#AIM-11972 Aimpoint Comp M4 High Battery Compartment



Aimpoint Micro

Micro H-1 & R-1 - Designed with the hunter in mind, these sights are the lightest red dot sights tough enough to bear the Aimpoint name. Small enough to be used anywhere that you could put iron sights, these sights can be used on any type of firearm or archery equipment. A lightweight rifle with an Micro H-1 & R-1 mounted on it remains a lightweight rifle! While the Micro T-1 is able to perform under extreme conditions while adding negligible weight to your weapon. Suitable for use on Rifles, Carbines, Shotguns, Submachineguns and Handguns, the Aimpoint Micro T-1 is ideal as a stand-alone sight, and can also be "piggybacked" on top of larger magnifying scopes, night vision, or thermal imaging optics.

#AIM-11910 Aimpoint Micro H-1 Black Finish

#AIM-11911 Aimpoint Micro R-1 Silver Finish

#AIM-11830 Aimpoint Micro T-1 Black Finish, Submersible to 80'

A.R.M.S. #31 Aimpoint Micro Spacer

Spacer for the #31™ Micro Throw Lever® Mount
#ARMS-31SP



A.R.M.S. #31 Aimpoint Micro Mount

Throw Lever Mount for the Aimpoint T-1 Micro sight.
#ARMS-31

Weaver Tactical Aimpoint Micro Mount

Flat top AR-15 owners can now mount their Aimpoint optics with the legendary hold of Weaver Rings & Bases. These new mounts accommodate both the Aimpoint Micro and feature 1/3rd co-witness with Mil-Spec iron sights, aircraft-grade 6061-T6 aluminum and Type III hard coat anodizing.
#105-WVR-99668



Aimpoint Front Lens Cover

#AIM-12223



Aimpoint Rear Lens Cover

#AIM-12224

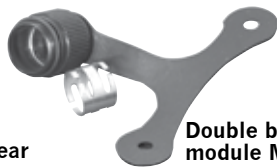

Double battery module M2, ML2
#AIM-12247



Aimpoint Kill Flash
#AIM-12239



M2, ML2, M3 & ML3 battery cap
#AIM-10634

A.R.M.S. #74 Comp M4 Throw Lever Mount

#ARMS-74



A.R.M.S. #74™ Spacer

1/2" Spacer for #74 Throw Lever Comp M4 Mount
#ARMS-74-SP

A.R.M.S. #74™ Extension

Cantilever Extension for #74 Mt. for Comp M4
#ARMS-74-EXT

Aimpoint 3X Magnifier

The Aimpoint 3XMag magnifying module is specially designed for use with Aimpoint sights and offers the shooter the ability to engage targets at extended ranges.
#AIM-11324 3X Magnifier



Samson Quick Flip Mounts for 3x

#SMC-QFM-3XM w/ ARMS Throw Lever Scope Mount
#SMC-QFM-3XE screw on mount



Twist Mount for 3X.
#AIM-12234



Twist Mount Ring Only
#AIM-12238

Twist Mount Base Only
#AIM-12236

Twist Mount Spacer with 4 Screws
#AIM-12227-TM



1/3N Lithium Battery
#AIM-10315



Aimpoint Carry Handle Mount
Dual Witness when used with Aimpoint's QRP Ring
#AIM-10174



EOTech XPS2

Tactical Unit

Uses 123 Lithium Batteries.

#EOT-XPS2-0 XPS2-0: 65 MOA ring & 1 MOA Dot

#EOT-XPS2-1 XPS2-1: 1 MOA Dot

#EOT-XPS2-2 XPS2-2: 65 MOA ring & Two 1 MOA Dots

EOTech XPS3

Military Unit - NV compatible

Uses 123 Lithium Batteries,

#EOT-XPS3-0 XPS3-0: 65 MOA ring & 1 MOA Dot

#EOT-XPS3-1 XPS3-1: 1 MOA Dot

#EOT-XPS3-2 XPS3-2: 65 MOA ring & Two 1 MOA Dots

The Eotech HWS is actively in use with military forces around the globe, including many special operations forces, like USSOCOM, where it is standard for close quarter, urban combat. Military units like Stryker Brigade, 10th Mountain and 3rd Infantry have chosen the holographic weapon sight as its optic of choice. It is battle proven to withstand the abuse that any harsh environment, high powered weapon platform, or military mission can dish out.

MODEL #	BATTERY	WATERPROOF	THROW LEVERS	NIGHT VISION COMPATIBLE	CONTROL Location
XPS2	123	YES / 33 ft	NO	NO	Rear
XPS3	123	YES / 33 ft	NO	YES	Rear
512	AA	YES / 10 ft	NO	NO	Rear
516	CR123	YES / 33 ft	NO	NO	Side
517	AA	YES / 10 ft	NO	YES	Side
552	AA	YES / 33 ft	NO	YES	Rear
553	123	YES / 60 ft	YES	YES	Rear
555	AA	YES / 33 ft	YES	YES	Rear
556	123	YES / 33 ft	NO	YES	Side
557	AA	YES / 10 ft	NO	YES	Side



EOTech 512

Tactical Unit

Uses AA Batteries.

#EOT-512-A65

EOTech 516

Side Buttons

Tactical Unit

123 Lithium Batteries

#EOT-516-A65

EOTech 517

Side Buttons

Tactical Unit

AA Batteries

#EOT-517-A65

EOTech 553

with ARMS throw lever. Black.

123 Lithium Cell Batteries,

#EOT-553-A65 Black

#EOT-553-A65-TAN Tan

EOTech 552

Military Unit - NV compatible

Uses AA Batteries,

#EOT-552-A65 A65 Reticle

#EOT-552-RX308 RX308 Reticle

EOTech 556

Side Buttons

Military Unit - NV compatible

123 Lithium Batteries

#EOT-556-A65

EOTech 557

Side Buttons

Military Unit - NV compatible

AA Batteries

#EOT-557-AR223

EOTech 555

with ARMS throw lever. Black.

AA Batteries,

#EOT-555-A65 Black

EOTech G23

3X Magnifier with side to side mount

#EOT-G23-FTS



A.R.M.S. 54

EOTech See-Thru Mount

#ARMS-54

(See-Thru Mount with Sight)



PRI M16/AR15 Standard Carry Handle Mount

A1/A2 DUAL-WITNESS HOLOGRAPHIC

The mounting rail is sufficiently low to allow the iron sights to be cointegrated with the red dot of the optical sight. The standard model fits on most standard issue firearms.

#SAM-3AH-OLO



PRI AR-15 High Rider Carry Handle Mount

High Rider Carry Handle Mount, see specs on Standard Model, The HR model sits higher to accommodate the larger specialized firearms available as retrofits.

#SAM-3BH-IGH

EOTech 557 with G23 3x Magnifier

Side Buttons

Military Unit - NV compatible

AA Batteries

3X Magnifier with side to side mount

#EOT-557-G23FTS



S.P.O.T. (Superior Precision Optical Technologies)

Red Dot Sporting Sight / Mark III
 High Quality, 30mm Red Dot Sporting Sight.
 • 3MOA or 6MOA Dot Models
 • 50 hour run time
 • Water Resistant
 • 11 position rheostat
 • Cantilever Scope Mount Included
#SPO-MK3-NR3 3MOA
#SPO-MK3-NR6 6MOA



30mm Cantilever Scope Ring

Cantilever Scope Ring available separately.
#SPO-MK3-CSM



Remote Optic Power Switch

• Power pressure switch instantly turns on
 • Reduce dead batteries
 • Switch pays for itself in battery savings
 • Easy to install and remove
#109-SL-A1SS Small Thread, 26mm thread (for S.P.O.T. Scope)
#109-SL-A1SL Large Thread, 28mm thread



Elcan Specter DR 1.6-6x Optical Sight

SpecterDR 1.5-6x, with its dual-role capability gives machine gun operators and designated marksmen a sweeping 1.5x view of the battlefield for target acquisition, then allows instant switching to 6x for accurate, long range precision fire and suppression.
#ATI-DGOV156-C1

Elcan Specter DR 1-4x Optical Sight

Represents a revolution in optical sight design. The world's first true dual-field of view combat optical sight, the Specter DR switches instantly from a 4X magnified sight to a 1X CQB sight with the flip of a lever.
#ATI-ELCAN-SDR

Elcan Specter OS 3.0 3X Optical Sight

Elcan set & forget ranging in reticle 5.56 Rapid aiming feature
#ATI-ELCAN-OS3-A2

Elcan Specter OS 3.0 3X Optical Sight - Marksman

Mil dot reticle, 1/2 moa clicks, marksmanship version, 5.56 External ballistic adjustment
#ATI-ELCAN-OS3-B2



Specter DR Bikini Style Lens Cover

#ATI-OSC-SDR-B For 1-4x - Black
#ATI-OSC-SDR-T For 1-4x - Tan
#ATI-OSC-SDR6-B For 1.5-6x - Black



Elcan GEN-4 SSL Optical Sight Mount (223)

Adjustable for windage and elevation.
#ATI-ELC-556-MT



Optional Short Rail for Elcan Mounts

3" Length
#ATI-ESR-003



Specter DR Anti Reflection Device

#ATI-ARD-SDR-B For 1-4x Black
#ATI-ARD-SDR-T For 1-4x Tan
#ATI-ARD-SDR6-B For 1.5-6x Black



Elcan Torque Knob Optical Sight Mount

Adjustable for windage and elevation.
#ATI-ELC-145-MT



Elcan Long Rail for Elcan Mounts

5" Length
#ATI-ELR-005

Specter DR Doctor Optic MRD Mount

#ATI-OSA-MDR-B For 1-4x Black
#ATI-OSA-MDR-T For 1-4x Tan



Trijicon ACOG®

Trijicon® introduces the official military version of the Triji-ACOG® 4x32 to the consumer market so you can now have latest in advanced combat optics.



- New to the consumer-perfect for varmint or big hunting
- Powered by Trijicon's patented fiber optics and tritium-based technology
- Incorporates a Bullet Drop Compensator (BDC) offering additional aiming points out to 800 meters or more
- Incorporates the innovative Bindon Aiming Concept™ (BAC)
- Multi-layer lens coating for maximum optical performance in any light
- Waterproof (500ft/150 meters) and nitrogen-filled to eliminate fogging
- Housing is made of forged, 7075-T6 aircraft aluminum alloy
- A spacer system is provided allowing the sight to be configured properly for varying weapons systems



#TJ-TA31F
Trijicon ACOG 4 X 32 Scope

#TJ-TA31-ECOS
Trijicon ACOG 4 X 32 Scope

#TJ-TA47-2
Trijicon ACOG 2 X 20
(A.R.M.S. Mount Not Included)

Trijicon ACOG® 6X48

Trijicon expands its extremely popular line of Trijicon ACOG® gunsights by introducing the newest addition – the rugged Trijicon ACOG® 6x48.

- Designed specifically for machine guns and military crew served weapons
- Enhances target identification and hit probability on shots out to 1,200 meters
- Powered by Trijicon's patented fiber optics and tritium-based technology
- Incorporates a Bullet Drop Compensator (BDC) offering additional aiming points estimated for trajectory
- Incorporates the innovative Bindon Aiming Concept™ (BAC)
- Waterproof (100 ft/30 meters) and nitrogen-filled to eliminate fogging
- Housing is made of forged, 7075-T6 aircraft aluminum alloy
- Lifetime Warranty
- Battery-Free



Trijicon ACOG 6X48
TA648MGO

Product ID

Product Description

Trijicon ACOG® 6X48 Models	
#TJ-TA648	6x48 Red Chevron BAC .223 Flattop Includes TA75 Adapter
#TJ-TA648-308	6x48 Red Chevron BAC .308 Flattop Includes TA75 Adapter
#TJ-TA648-50	6x48 Red Chevron BAC .50 Bmg Flattop Includes TA75 Adapter
#TJ-TA648MGO	6x48 Red Chevron BAC .223, M1913 Rail
#TJ-TA648MGO-308	6x48 Red Chevron BAC .308, M1913 Rail
#TJ-TA648MGO-50	6x48 Red Chevron BAC .50 BMG, M1913 Rail Adapter
#TJ-TA648TRD-A	6x48 Amber Chevron BAC .223, 8.0 MOA Trijicon RedDot
#TJ-TA648TRD-308	6x48 Red Chevron BAC .308, 8.0 MOA Trijicon RedDot
#TJ-TA648TRD-50	6x48 Red Chevron BAC .50 BMG, 8.0 MOA Trijicon RedDot

A.R.M.S. #10

ACOG Channel Mount with Thumb Nuts
#ARMS-10



A.R.M.S. #19S ACOG

ACOG Single Throw Lever
#ARMS-19SACOG



A.R.M.S. #19 ACOG

Dual Lever ACOG Mount
#ARMS-19ACOG



A.R.M.S. #19LD

ACOG Low Dual Throw Lever
#ARMS-19LD



Product ID

Product Description

Trijicon ACOG® 1.5 X Models	
#TJ-TA24-4	1.5 X 24 ACOG Dual Illumination Amber Crosshair Reticle For Special Rings
#TJ-TA26S-10	1.5x16 Amber Ring & Dot Reticle with Special Ring Short Housing
#TJ-TA44-2	1.5x16 Dual Illumination Amber Triangle Reticle
#TJ-TA44-4	1.5x16 Dual Illumination Amber Crosshair Reticle
#TJ-TA44-5	1.5x16 Dual Illumination Amber Dot Reticle
#TJ-TA44S-10	1.5x16 Amber Ring & Dot Reticle with Short M16 Base Housing
#TJ-TA45-2	1.5x24 ACOG Amber Triangle Reticle
#TJ-TA45-4	1.5x24 ACOG Amber Crosshair Reticle
Trijicon ACOG® 2 X Models	
#TJ-TA47-2	2x20 ACOG Amber Triangle Reticle
#TJ-TA47-4	2x20 ACOG Amber Crosshair Reticle
#TJ-TA47-6	2x20 ACOG Amber Dot Reticle
Trijicon ACOG® 3 X Models	
#TJ-TA50-2	3x24 ACOG Amber Triangle Reticle
#TJ-TA50-4	3x24 ACOG Amber Crosshair Reticle
#TJ-TA33-8	3x30 ACOG Dual Illumination Amber Chevron .223 Ballistic Reticle W/ TA60 Mount
#TJ-TA33-9	3x30 ACOG Dual Illumination Amber Chevron .308 Ballistic Reticle
Trijicon ACOG® 3.5 X Models	
#TJ-TA11	3.5x35 Scope, Dual Illumination Red Donut .223 Ballistic Reticle
#TJ-TA11B	3.5x35 Dual Illumination Red Circle Chevron Reticle
#TJ-TA11C	3.5x35 Dual Illumination Red Donut .308 Ballistic Reticle
#TJ-TA11D	3.5x35 Dual Illumination Red Triangle .223 Ballistic Reticle
#TJ-TA11E	3.5x35 Dual Illumination Red Chevron .308 Ballistic Reticle W/ TA51 Mount
#TJ-TA11F	3.5x35 Dual Illumination Red Chevron .223 Ballistic Reticle W/ TA51 Mount
#TJ-TA11H	3.5x35 Scope, Dual Illumination Red Horseshoe .223 Ballistic Reticle with TA51 Mount
#TA11H-308	3.5x35 Scope, Dual Illumination Red Horseshoe .308 M240 BDC Reticle with TA51 Mount
Trijicon ACOG® 4 X Models	
#TJ-TA01	4x32 Full Illumination Red Crosshair .223 Ballistic Reticle
#TJ-TA01B	4x32 Full Illumination Red Crosshair .308 Ballistic Reticle
#TJ-TA01LAW	4x32 Full Illumination LAPD Red Crosshair Reticle
#TJ-TA01-ECOS	4x32 Center Illumination Dark Earth Brown Scope with Amber Crosshair
#TJ-TA01NSN	4x32 Center Illumination Amber Crosshair Reticle .223 Ballistic Reticle
#TJ-TA31	4x32 Dual Illumination Red Donut .223 Ballistic Reticle
#TJ-TA31H-G	4x32 Dual Illuminated Green Horseshoe Reticle, BAC, & Flattop Mount
#TJ-TA31H-68	4x32 Dual Illuminated Red Horseshoe Reticle, BAC, & Flattop Mount
#TJ-TA31RCO-M150CP	4x32 ARMY Rifle Combat Optic For The M150 W/ TA51 Mount
#TJ-TA31A	4x32 Dual Illumination Red Triangle .223 Ballistic Reticle
#TJ-TA31-ECOS	4x32 Dual Illumination Dark Brown Red Crosshair .223 Ballistic Reticle W/ 7.0 MOA Docter Sight, A.R.M.S. Throw Lever Mount
#TJ-TA31F	4x32 Dual Illumination Red Chevron .223 Ballistic Reticle
#TJ-TA31H	4x32 Dual Illumination W/ Red Horseshoe Reticle And M4 BDC
#TJ-TA31RCO-M4CP	4x32 USMC Rifle Combat Optic For The M4 W/ TA51 Mount
#TJ-TA31RCO-A4CP	4x32 USMC Rifle Combat Optic For The A4 W/ TA51 Mount
Trijicon ACOG® 5.5 X Models	
#TJ-TA55	5.5x50 ACOG Dual Illumination Red Chevron .223 Ballistic Reticle
#TJ-TA55A	5.5x50 ACOG Dual Illumination Red Chevron .308 Ballistic Reticle

Trijicon AccuPoint®

Trijicon® introduces the new Trijicon AccuPoint® with a crosshair reticle – the world’s only battery-free illuminated crosshair-eliminating the potential for failure.

- By popular request, Trijicon® delivers the new crosshair reticle, illuminated by Trijicon’s patented fiber optic and tritium-based technology for effective aiming
- Innovative fiber optics automatically adjust the brightness level and contrast of the aiming point to available light conditions
- Improved Manual Brightness Adjustment Override
- Multi-layer coated lenses for the superior light transmission with no distortion
- Quick-focus eyepiece and long eye relief
- 1.25-4x24, 3-9x40 or 2.5-10x56 magnification options
- Crafted from aircraft quality, hard anodized aluminum



Product ID	Product Description
Trijicon AccuPoint® 1-4x24 Models	
#TJ-TR24	1-4x24 30mm with BAC, Amber Triangle Reticle
#TJ-TR24-3	1-4x24 30mm, German #4 Crosshair with Amber Dot
#TJ-TR24R	1-4x24 30mm with BAC, Red Triangle Reticle
Trijicon AccuPoint® 1.25-4 X 24 Models	
#TJ-TR21	1.25-4x24 Amber Triangle Reticle
#TJ-TR21R	1.25-4x24 Red Triangle
#TJ-TR21-3	1.25-4x24 German # 4 Crosshair With Amber Dot
Trijicon AccuPoint® 2.5-10 X 56 Models	
#TJ-TR22	2.5-10x56 Amber Triangle Reticle
#TJ-TR22R	2.5-10x56 Red Triangle Reticle
#TJ-TR22-1	2.5-10x56 Standard Duplex Crosshair with Amber Dot
#TJ-TR22-2	2.5-10x56 Mil-Dot Crosshair with Amber Dot
Trijicon AccuPoint® 3-9 X 40 Models	
#TJ-TR20	3-9x40 BAC Amber Triangle
#TJ-TR20R	3-9x40 BAC Red Triangle
#TJ-TR20-1	3-9x40 Standard Duplex Crosshair W/ Amber Dot
#TJ-TR20-2	3-9x40 Mil-Dot Crosshair W/ Amber Dot
Trijicon AccuPoint® 5-20x50 Models	
#TJ-TR23	5-20x50 with BAC, Amber Triangle Reticle
#TJ-TR23-1	5-20x50, Standard Crosshair with Amber Dot
#TJ-TR23-2	5-20x50, Mil-Dot Crosshair with Amber Dot
#TJ-TR23G	5-20x50 with BAC, Green Triangle Reticle
#TJ-TR23R	5-20x50 Riflelescope with BAC, Red Triangle Reticle

A.R.M.S. #15Trijicon™ Reflex Mt. Platform

A.R.M.S. has succeeded in developing an ultra low profile mounting platform for the Trijicon Reflex sight. The combination of the A.R.M.S. repeat zero and patented Throw Lever system and the Reflex sight provide the shooter with built in streamline appearance, function and superb fast action accuracy.



The #15 platform is attached to the bottom of the sight by 3 screws that are supplied with the platform, and provides 2 positive locking Throw Levers with A.R.M.S. patented no-mar buffer pads, no gunsmithing required. The #15 Reflex mount platform meets or exceeds all mil-spec requirements just like all other A.R.M.S. standard mil-spec products.

#ARMS-15

A.R.M.S. #15SP Reflex Mount Spacer
#ARMS-15SP



ARMS #1 with Trijicon™ Interface

(Shown With Sight, & A.R.M.S. #1 Not Included)
#ARMS-1-TRIJ-REFLEX



Trijicon Reflex®

Trijicon introduces the Trijicon® Reflex, a new non-magnified, self-luminous sight engineered to provide additional light gathering capabilities.

- New 42mm lens gives you the largest sight picture possible
- Innovative fiber optics automatically adjust the brightness level and contrast of the aiming point to available light conditions
- Parallax-free sighting enables fast, both-eyes-open target acquisition and accurate aiming
- Tritium-phosphor lamp aiming reticle glows in low-light conditions for precise shot placement
- Adjustment range of +/- 30 MOA (once click per inch at 100 yards)
- Manufactured from cast A356-T6 aluminum with hard coat anodizing



Product ID	Product Description
Trijicon Reflex® RX30	
#TJ-RX01	6.5 MOA Amber Dot Recticle (Without Mount)
#TJ-RX01-10	6.5 MOA Amber Dot Recticle With M16 Handle Mount
#TJ-RX01-11	6.5 MOA Amber Dot Recticle With Weaver Mount
#TJ-RX01-14	6.5 MOA Amber Dot Recticle With Flattop Mount
#TJ-RX01-17	6.5 MOA Amber Dot Recticle With H & K Mount
#TJ-RX01-23	6.5 MOA Amber Dot Recticle With A.R.M.S # 15 Throw Lever Mount
#TJ-RX01-25	6.5 MOA Amber Dot Recticle With M16/AR15 Top Of Handle Mount
#TJ-RX01NSN	4.5 MOA Amber Dot With Flattop Mount
#TJ-RX06	12.9 MOA Amber Triangle Reticle (Without Mount)
#TJ-RX06-10	12.9 MOA Amber Triangle Reticle With M16 Handle Mount
#TJ-RX06-11	12.9 MOA Amber Triangle Reticle With Weaver Mount
#TJ-RX06-14	12.9 MOA Amber Triangle Reticle With Flattop Mount
#TJ-RX06-17	12.9 MOA Amber Triangle Reticle With H & K Mount
#TJ-RX06-23	12.9 MOA Amber Triangle Reticle With ARMS #15 Throw Lever Mount
#TJ-RX06-25	12.9 MOA Amber Triangle Reticle With M16/AR15 Handle Mount
#TJ-RX30	42mm Reflex 6.5 MOA Amber Dot Recticle (Without Mount)
#TJ-RX30A-51	42mm Reflex 6.5 MOA Amber Dot Recticle With Mounting adaptor
#TJ-RX30-11	42mm Reflex 6.5 MOA Amber Dot Recticle With Weaver Mount
#TJ-RX30-14	42mm Reflex 6.5 MOA Amber Dot Recticle With Flattop Mount
#TJ-RX30-17	42mm Reflex Amber 6.5 MOA Dot Recticle With H&K Mount
#TJ-RX30-23	42mm Reflex 6.5 MOA Amber Dot Recticle With ARMS #15 Throw Lever Flattop Mount
#TJ-RX30-25	42mm Reflex Amber 6.5 MOA Dot Recticle M16/AR15 Top Of Handle Mount

Trijicon TriPower®

The World's First Triple-Illuminated Reflex Sight

The Trijicon TriPower provides a perfect solution for those requiring fast action, both-eyes-open aiming precision and speed in a diverse array of lighting conditions—ranging from dim to completely dark—even when those conditions might change in the same round of fire. This super dependable reflex-style sight features an exclusive red chevron-shaped reticle illuminated by three lighting sources:

1. Integrated Fiber Optic System
2. Tritium-Illuminated reticle
3. On-Call Battery Backup

#TJ-TX30



A.R.M.S. #22 TX-30

Trijicon™ Tri-Power Throw Lever Mount
#ARMS-22TX30

Trijicon RMR™

The new Trijicon RMR™ (Ruggedized Miniature Reflex) has been introduced to match the legendary toughness of the Trijicon ACOG® (Advanced Combat Optical Gunsight).

It can be teamed up with the ACOG® or AccuPoint® for the ultimate in fast target acquisition or precise aiming at extended distances.



The RMR™ offers two illumination configurations. One choice is an innovative LED (light emitting diode) insert that automatically adjusts for brightness in any lighting situation and ensures optimum visibility of dot against the target. The second option is a dual-illuminated, battery-free model featuring Trijicon fiber optics and tritium. Accuracy is further enhanced with adjustments for windage and elevation and clarity is assured with the sight's ultra-clear, hard-coated lens.



Trijicon RMR™ Dual Illuminated Sight



Trijicon RMR™ Sight (LED)

Trijicon RMR™ Dual Illuminated Sight — 7.0 MOA Red Dot

Developed to improve precision and accuracy with any style or caliber of weapon, the Trijicon RMR™ (Ruggedized Miniature Reflex) is designed to be as durable as the legendary ACOG. The RM04 is a battery free sight, featuring Trijicon fiber optics and tritium.

- #TJ-RM03** Dual Illuminated Sight — 13.0 MOA Amber Dot
- #TJ-RM04** Dual Illuminated Sight — 7.0 MOA Amber Dot
- #TJ-RM05** Dual Illuminated Sight — 9.0 MOA Amber Dot

Trijicon RMR™ Mounts

- #TJ-RM33** RMR™ Low Picatinny Rail Mount
- #TJ-RM34** RMR™ Tall Picatinny Rail Mount
- #TJ-RM35** RMR™ Mount for TA01NSN ACOG
- #TJ-RM36** RMR™ Mount for 1.5x, 2x & 3x ACOG® Models
- #TJ-RM38** RMR™ Mount for 4x ACOG



Trijicon RMR™ Low Picatinny Rail Mount

Trijicon RMR™ Sight (LED) — 4.0 MOA Red Dot

Developed to improve precision and accuracy with any style or caliber of weapon, the Trijicon RMR™ (Ruggedized Miniature Reflex) is designed to be as durable as the legendary ACOG. The RM01 is an LED sight powered by a standard CR2032 battery.

- #TJ-RM01** 4.0 MOA Red Dot
- #TJ-RM02** 8.0 MOA Red Dot



Trijicon RMR™ Mount for 4x ACOG



Trijicon RMR™ Mount for TA01NSN ACOG



Trijicon RMR™ High Picatinny Rail Mount

Trijicon® Bright and Tough Night Sights

Trijicon Bright & Tough™ Night Sights are three-dot iron sights that increase night-fire shooting accuracy by as much as five times over conventional sights. Equally impressive, they do so with the same speed as instinctive shooting—and without the need for batteries. Housed in a metal body and cushioned within silicon rubber, Bright & Tough Night Sights feature a unique shock-resistant design that is patented by Trijicon. Each lamp is capped with a sapphire jewel to help evenly distribute the light while protecting the lamp from solvents and puncture. Contained within aluminum cylinders for additional protection, the lamps are mounted on silicon rubber cushions to withstand shock and heavy recoil. Green lamps are warranted for 12 years from the date of manufacture.



(TJ-HK07)

(TJ-RE04)

Trijicon-Pistol 3 Dot Front & Rear Night Sight

- #TJ-BE10** Beretta PX4 Storm
- #TJ-BR02** Browning Hi-Power
- #TJ-CZ02** CZ75 w/ dovetail front
- #TJ-CA22** Colt Enhanced Gov't
- #TJ-CA23** Colt E Officers/Combat
- #TJ-GL01** Glock 17, 19, 22, 23, 24, 26, 27, 34, 35, 37
- #TJ-GL04** Glock 20, 21, 29, 30, 31, 32, 33, 36
- #TJ-HK06** H&K USP models
- #TJ-HK08** H&K USP Compact 3
- #TJ-KB01** Kimber
- #TJ-SG01** SIG P225, 226, 228, 239
- #TJ-SG03** SIG P220, 229

- Easily acquire sights in any lighting
- Three green tritium lamps
- Extra large dots with white rings for increased visibility
- Rugged metal sight housing



(TJ-BE10)

(TJ-BR02)

(TJ-CZ02)

(TJ-CA22)

(TJ-GL01)

(TJ-HK06)

(TJ-KB01)

(TJ-SG01)

Trijicon-Rifle Front & Rear Night Sight

- #TJ-HK07** The HK07 will fit all H&K military style rifle, carbines, SMG's and the SP89 pistol.
- #TJ-RE04** Remington shotgun models 870, 1100 & 1187.



Vortex SPARC Red Dot Scope

It takes a SPARC to light a fire. The new, compact, daylight-bright SPARC (Speed Point Aiming for Rapid Combat) is packed with performance features and lends itself to a wide variety of firearm platforms-including AR15s, shotguns, and pistols. The modular three-piece base offers four separate mounting heights for user- and weapon-specific customization. Digital rear-facing and side controls for power on/off, dot brightness and night vision mode. Aircraft-grade 6061-T6 aluminum body. Get on target fast with the SPARC.



The versatile multi-height mount system of the SPARC accommodates AR15s needing absolute or lower 1/3 co-witness heights and uses a standard Weaver or Picatinny base (not included). The SPARC is also threaded to accept accessory ARD and comes with a 2x doubler.

#115-V-SPRC

Vortex StrikeFire Red Dot Scope

When the situation demands fast shooting... and a big scope with a narrow field of view won't cut it, the StrikeFire red dot riflescope lets you shoot quickly with both eyes open! With unlimited field of view and eye relief-nothing gets you on target faster than this tough, shockproof and waterproof red dot scope.



- Shockproof with rugged one-piece 30mm aluminum alloy tube.
- High recoil caliber rating-tested with .375 H&H Magnum for 1000 rounds.
- Included extra-high 30mm ring puts scope's bore center 37 mm (1.46 inches) above the base height. Commonly used for mounting with a Flat Top AR15, providing absolute co-witness with iron sights.

#115-V-SF-BR-AR15

Vortex VMX3 Magnifier

With 3x magnification and a durable armored construction, the Vortex VMX3 magnifier can be used to quickly add precise, longer ranging ability to red dot type sights including the Vortex SPARC and StrikeFire red dots. The VMX3 is easy to use and does not require any special sight-in. Just zero-in the red dot scope as normal, then add the VMX3 behind the scope for the additional magnification.

#115-V-VMX3

Vortex Bubble Level

For the most precise long-range shooting, use the bubble level to ensure that the rifle is perfectly vertical. This will eliminate potential error caused by shooting a canted rifle. Mounts quickly and easily to the riflescope tube.

#115-V-RAC-VT-BL3 30mm Tubes



Vortex Diamondback Riflescope

The Diamondback-loaded with features for crystal clear, tack-sharp images.

One-Inch Tube

- 115-V-DBK-M-01P
- 115-V-DBK-04-BDC
- 115-V-DBK-412B

- 3-9X40 Rifle Scope - V-Plex Reticle
- 4-12x40 Rifle Scope - Dead-Hold BDC Reticle
- 4-12x40 AO Rifle Scope - Dead-Hold BDC Reticle



Vortex Viper Riflescope

Discover a riflescope with incredible performance features at a price that should have pulled a few more hundreds from your wallet than it did.

PST (Precision Shooting Tactical) 30mm Tube

- 115-V-PST-14ST-A 1-44X24 · TMCQ MOA Reticle
- 115-V-PST-14ST-M 1-4X24 · TMCQ MRAD Reticle
- 115-V-PST-210S1-A 2.5-10X44 · EBR-1 MOA Reticle
- 115-V-PST-416S1-A 4-16X50 · EBR-1 MOA Reticle
- 115-V-PST-416F1-A 4-16X50 FFP · EBR-1 MOA Reticle
- 115-V-PST-624F1-A 6-24X50 FFP Rifle Scope · EBR-1 MOA Reticle
- 115-V-PST-624S1-A 6-24X50 Rifle Scope · EBR-1 MOA Reticle

30mm Tube

- #115-V-VPR-M-06BDC 6.5-20X50 PA Riflescope · Dead-Hold BDC Reticle
- #115-V-VPR-M-06MD 6.5-20X50 PA Riflescope · Mil Dot Reticle
- #115-V-VPR-M-05BDC 6.5-20x44 PA Riflescope · Dead-Hold BDC Reticle
- #115-V-VPR-M-05MD 6.5-20x44 PA Riflescope · Mil Dot Reticle



Vortex Crossfire Riflescope

Built to exceed the performance standards of similarly-priced riflescopes, the Crossfire riflescope is standing by-ready and more than willing to assist you with filling that tag.

30mm Tube

- #115-V-CRF-624-AOHT 6-24x50 AO · Mil Dot Illuminated Reticle
- #115-V-CRF-650-AOHT 4-16x50 AO · Mil Dot Illuminated Reticle

One-Inch Tube

- #115-V-CRF-04P 4-12X40 · V-Plex Reticle
- #115-V-CRF-01-ILLD 3-9x40 · V-Brite Illuminated Reticle
- #115-V-CRF-01P 3-9x40 · V-Plex Reticle





Nightforce Optics

The philosophy of Nightforce is highly specialized and focused on building the ultimate instrument for the application. Our research and testing has developed new standards in manufacturing and quality control. Every Nightforce scope is assembled at our factory in North Central Idaho. All Nightforce scopes are 100% inspected and certified, passing vigorous testing prior to shipping. Our commitment to ultimate riflescope performance by using cutting edge technology and advanced mechanical designs is unparalleled in the industry. All NXS models share exceptional features, making them the finest riflescopes ever produced.



NXS 1-4x24 Compact

NXS 1-4x24 Compact

Nightforce NXS 1-4x24 Compact

Hunting: dangerous game, running shots, dense conditions.
Tactical: close quarter combat, 3-gun competition
#117-NXS1424 FC-2 Reticle

NXS 2.5-10x32 Compact

Hunting: close to long range, low-light situations.
Tactical: long-range w/close-in capability, low light
#117-NXS251032 NP-R2 Reticle with ZeroStop

Nightforce NXS 3.5-15x50

Hunting: traditional, extremely versatile
Tactical: Military Small Arms: lower mounting
#117-NXS1550 NP-R1 Reticle
#117-NXS1550-F1-MLR MLR Reticle with ZeroStop

Nightforce NXS 3.5-15x56

Hunting: traditional, ultimate low light performance, versatile
Tactical: LE Snipers, unparalleled twilight performance
#117-NXS1556ZS NP-R1 Reticle with ZeroStop

Nightforce NXS 5.5-22x50

Hunting: Big Game, Medium to Long-Range · vast open terrain, Varminting.
Tactical: shooting and hard target acquisition
#117-NXS2250ZS MIL-DOT Reticle with ZeroStop

Nightforce NXS 5.5-22x56

Hunting: Big Game, Medium to Long-Range · vast open terrain, Varminting.
Tactical: shooting and hard target acquisition
#117-NXS2256ZS NP-R1 Reticle with ZeroStop

Nightforce NXS 8-32x56

Long-range & Ultra Long-Range: benchrest shooters, specialized ultra long-range firearms
#117-NXS3256 MIL-DOT Reticle

Horus Vision Scopes

It's a straightforward proposition—the more light that passes through the scope, the better you can see and the more accurately you can shoot. Horus Vision builds all our scopes using the best glass and best coatings available. They are unparalleled in brightness and clarity, from the center to the edges of the lens. Our optics were independently tested to be on par with the world's best, and our demanding calibration means a mil is a true mil, no matter what.

Horus Vision Falcon

Illuminated 5-20x50 Solid Steel Scope

A superb scope for all needs. Its solid steel tube is tough enough for heavy caliber use out to 1500 yards plus.
#HV-OJ02551



Horus Vision Predator

8-26x50 SMOA Non-Illuminated Varmint Scope

Thin reticle lines for small targets. Calibrated in inches. For 1200 yards plus, depending on rifle and ammo.
#HV-OJ0708N



Horus Vision Hawk

Non-Illuminated 3-12x50 Scope

Versatility meets distance. This simple, no-nonsense scope is excellent for shots out to 800 yards.
#HV-OJ4254N6



Horus Vision Raptor

Non-Illuminated 4-16x50 Scope

For serious shooters wanting extra reach and precision. For 1000 yards plus, depending on rifle and ammo.
#HV-OJ0254N



Horus Vision Talon

1-4x24 Dangerous Game Optic

Eliminate close-in targets with incredible speed. Ranges from point blank to 800 yards.
#HV-OJ05011



Horus Vision ASLI

Angle Slope Level Indicator

The ASLI gives sophisticated marksmen a slope indicator and cant indicator in one. Correct your bullet flight with confidence!

- #HV-ASLI-30 30mm Ring Mount
- #HV-ASLI-34 34mm Ring Mount
- #HV-ASLI-SR Side Rail Mount
- #HV-ASLI 1" Ring Mount



Weaver Grand Slam Series

Weaver's award-winning Grand Slam® is consistently rated as one of the best all-around scopes available.



Model	Pow/Obj	Reticle	Finish	Special Features
#105-WVR-800472	3-10 x 40	Ballistic-X	Matte	
#105-WVR-800475	4.5-14 x 40	Dual-X	Matte	AO
#105-WVR-800477	4.5-14 x 40	Ballistic-X	Matte	AO
#105-WVR-800478	6-20 x 40	Ballistic-X	Matte	AO
#105-WVR-801040T	3-10 x 40	Mil-Dot	Matte	Tac. Tur.

Weaver Super Slam Series

The new Super Slam scopes are loaded with all the latest technological advances of modern high-end optics.



Model	Pow/Obj	Reticle	Finish	Special Features
#105-WVR-800315	2-10 x 42	EBX	Matte	
#105-WVR-800320	2-10 x 42	Dual-X	Matte	
#105-WVR-800335	3-15 x 42	EBX	Matte	Side Focus
#105-WVR-800355	4-20 x 50	EBX	Matte	Side Focus

Weaver 40/44 Series

The 40/44 Series™ boasts an increase in scope offerings all with either 40mm or 44mm objectives.



Model	Pow/Obj	Reticle	Finish	Special Features
#105-WVR-849511	3-9 x 40	Dual-X	Matte	
#105-WVR-849512	3-9 x 40	Ballistic-X	Matte	
#105-WVR-849530	3-10 x 44	Dual-X	Matte	
#105-WVR-849531	3-10 x 44	Dual-X	Silver	
#105-WVR-849532	3-10 x 44	Ballistic-X	Matte	
#105-WVR-849507	3-9 x 40	Dual-X	Matte	50 YD Parallax
#105-WVR-849520	2.8-10 x 44	Dual-X	Matte	Aspherical
#105-WVR-849521	2.8-10 x 44	Dual-X	Silver	Aspherical
#105-WVR-849540	4-12 x 44	Dual-X	Matte	AO
#105-WVR-849542	4-12 x 44	Ballistic-X	Matte	AO
#105-WVR-849550	6.5-20 x 44	Dual-X	Matte	AO
#105-WVR-849552	6.5-20 x 44	Varminter	Matte	AO

F/C = Fine Crosshair
STT = Semi Target Turret
A/O = Adjustable Objective

Butler Creek Flip-Open Scope Covers

Simply the ultimate scope lens protection for hunters and shooters. They're custom-fit to your scope, create a water-tight, airtight seal, and open with a touch of your thumbs, so you can put your shot through the narrow window of opportunity in the most extreme conditions.



- Fast, flip-open design - keep your eye on the target.
- Silent spring hinges won't spook game.
- Water-tight, custom-fit friction mounts anchor them to your scope.
- Air-tight semi-O-ring keeps out dust and moisture.
- Tested to -40°F.
- Truly ambidextrous.
- Weighs less than an ounce.
- Also made for spotting scopes.



Objective cover

Eye Piece

Objective Flip-Open Rifle Scope Cap Cover

ID	Scope Diam (in.)	ID	Scope Diam (in.)	ID	Scope Diam (in.)
#100-BC-30010	1.000	#100-BC-30150	1.558	#100-BC-30310	1.998
#100-BC-30040	1.095	#100-BC-30170	1.612	#100-BC-30330	2.043
#100-BC-30020	1.221	#100-BC-30190	1.646	#100-BC-30340	2.100
#100-BC-30025	1.181	#100-BC-30200	1.700	#100-BC-30390	2.220
#100-BC-30030	1.300	#100-BC-30210	1.735	#100-BC-30400	2.250
#100-BC-30035	1.340	#100-BC-30230	1.760	#100-BC-30430	2.310
#100-BC-30050	1.387	#100-BC-30250	1.800	#100-BC-30440	2.360
#100-BC-30070	1.429	#100-BC-30260	1.820	#100-BC-30450	2.410
#100-BC-30090	1.485	#100-BC-30270	1.840	#100-BC-30460	2.430
#100-BC-30100	1.500	#100-BC-30280	1.890	#100-BC-30470	2.461
#100-BC-30110	1.54 x 1.34	#100-BC-30290	1.919	#100-BC-30480	2.515
#100-BC-30120	1.75 x 1.53	#100-BC-30300	1.960	#100-BC-30510	2.575
#100-BC-30130	1.530				

Weaver Classic Rimfire Series

Built for everyday plinking or the specialized needs of adult air rifles.



Model	Pow/Obj	Reticle	Finish	Special Features
#105-WVR-849398	3 - 9 x 32	Dual-X	Matte	Adj. Obj

Weaver Classic K-Series Series

The K-Series™ fixed power scopes are solidly built for heavy recoil punishment and hold up to 10,000 rounds from a .375 H&H magnum rifle.



Model	Pow/Obj	Reticle	Finish
#105-WVR-849415	4 x 38	Dual-X	Matte
#105-WVR-849418	6 x 38	Dual-X	Matte

Weaver Classic T-Series

These scopes feature the incredibly accurate QuadZero™ adjustment system that gives you more accuracy and elevation control.



Model	Pow/Obj	Reticle	Finish	Special Features:
#105-WVR-849969	36 x 40	1/8MOA Dot	Silver	AO/SunShade
#105-WVR-849970	24 x 40	F/C	Matte	AO/SunShade
#105-WVR-849974	36 x 40	1/8MOA Dot	Matte	AO/SunShade
#105-WVR-849976	24 x 40	F/C	Gloss	AO/SunShade
#105-WVR-849981	36 x 40	F/C	Silver	AO/SunShade

Weaver Classic Handgun Series

Designed for the tremendous recoil of 1,000 rounds from a .454 Casull® revolver, these scopes deliver rugged, reliable, repeatable accuracy.



Model	Pow/Obj	Reticle	Finish
#105-WVR-849425	4 x 28	Dual-X	Gloss
#105-WVR-849429	2.5-8 x 28	Dual-X	Matte

BSA Catseye Series CAT624X44SP

Clear objectives provide great light transmission for dusk-to-dawn use and they deliver ultra-high resolution and performance. A durable and reliable design.

#BSA-CAT624X44SP

(CAT624X44SP Shown)



(CAT312X44SP & CAT416X44SP Shown)

BSA Catseye Series CAT312X-44SP

This new side parallax feature is convenient and user friendly, allowing for easy and precise parallax adjustment. A durable and reliable design, with an integrated slanted "hood" on the objective, functioning as a built in sunshade.

#BSA-CAT312X44SP

BSA Catseye Series CAT416X44SP

The Catseye™ series is equipped with push/pull locking turrets. The Catseye™ is 1/4 MOA, that means one click will move the bullet 1/4" at 100 yards. (Note, if you zero at a different yardage, say 50 yards, one click will move the bullet only 1/8" at 50 yards.)

#BSA-CAT416X44SP

BSA Pistol Scope

Pistol scope 2x20 1" Tube

#BSA-PS2X20SIL Silver

#BSA-PS2X20 Black

**BSA Deer Hunter Shotgun Scope**

Shotgun scope 2.5x20 1" Tube

A hard working scope designed for the hard working man. Camera quality glass lens are ground to give you an undistorted and clear image.

#BSA-DH25X20

**Xenonics SuperVision - Digital Night Vision (2-8x)**

Nothing less than a paradigm shift in "night vision" technology, SuperVision utilizes the most sensitive and sophisticated CCD sensor in the world to capture invisible moonlight and digitally process the information, in the form of pixels, into a sharp, clear picture on a high-resolution display.

Product Features

- 2-8x Zoom Magnification
- Digital CCD Technology
- High Resolution Display
- Lithium-ion Battery
- Ruggedized Housing
- Comfortable Hand Strap
- Pre-Set Gain Controls
- Easy Carry Bag

Technical Specifications

- Resolution: 1280x768
- Min. Illumination: 0.0003lux
- Magnification: 2x-8x zoom
- Focus: 20' to infinity
- Diopter Adjustment: +2 to -6
- Field of View: 525' at 1000 yards
- Weight: 20ozs

SuperVision's™ performance exceeds military-grade (Gen III) night vision in every aspect: greater resolution, better clarity, longer range and the most significant factor of them all, zoom capability. SuperVision's patent-pending digital technology offers a 2x to 8x zoom magnification, something no other form of night vision can match. Military-grade night vision requires the installation of a cumbersome and awkward 3x magnifier, which then only gives one level of magnification at the expense of greater bulk and weight.

#XEN-001

**BSA Sweet Series S17-312X40**

The Windage and Elevation turrets have zero reset with "Allen" screw. Each model in the Sweet 17 series have an adjustable parallax setting of 10 to infinity. (With the exception of the model S17-27x32 which is 7.5 to infinity)

#BSA-S17-312X40



(S17-312X40 Shown)

**BSA Sweet Series S22-27X32SP**

The main feature of the Sweet 22 is their ability to compensate for bullet trajectory by specific grain weight. The elevation drum will compensate for .22cal grain weights of 36, 38, and 40. The Windage and Elevation turrets have zero reset with "Allen" screw.

#BSA-S22-27X32SP

BSA Sweet Series S22-39X40SP

The Sweet 22™ is 1/4 MOA, that means one click will move the bullet 1/4" at 100 yards.

#BSA-S22-39X40SP

BSA Sweet Series 223-312X40A/O

Hot New Scope that is catching on Fast with Varmint and Target Shoots. They feature a quick change turret system specially calibrated for multiple grain weights for the calibers: .17HMR, .22LR, .223, .243, .270, .30-06.

#BSA-223-312X40AO



(223-312X40A/O Shown)

BSA Panoramic Scope

30mm Pano multi-reticle sight

#BSA-PMRS

**Advanced Tactical Camera**

Pacific Concepts/HBD Inc has been providing innovative solutions to Industry and Law Enforcement agencies for over 37 years. After over a year in R&D, they now have a new product to introduce. We developed this camera in partnership with a major video camera maker. This is the first hardened video camera developed for mounting on a firearm. Waterproof to 10 ft, runs off two AA batteries.

On the law enforcement side we

have had requests for mounts for ATV's, bike patrols, water bikes, boats and a hand held, waterproof, easy to use camera for boarding boats. The corrections field is using them for video taping cell extractions, deployment of less lethal launchers and riot situations.

Additional Specifications:

- Waterproof up to 3 meters and shock resistant for extreme conditions.
- Mount included for RIS/RAS interface system or weaver style mount. our product
- 640X480 VGA resolution at 30 frames per second.
- Both USB and RCA cables are included for easy playback on a PC or TV (NTSC).
- Onboard memory is 32mb (good for about 5 minutes).
- SD card expansion works with up to a 2 gig card (approximately 1 hour of audio and video at best quality) SD card is not included.
- Operates on two AA batteries, approximately 2 hours of use on a set of batteries (not included).

#107-PC-ATC



Bushnell Elite 3200 Rifle Scope

The Elite 3200 offers multi-coated optics for generous light transmission and crisp image quality. Our exclusive, patented Rainguard HD lens coating reduces large drops of water to near-microscopic specks, dramatically increasing light transmission and resulting in a remarkably clear image in wet weather.
#100-B-321040M 10 x 40mm



Bushnell Elite 6500 Rifle Scope

The Elite 6500 Series contains the world's most versatile riflescope, featuring a 6.5x magnification range, one of the widest in the industry. These scopes are ideal for hunters who want a scope they can use in the brush as well as on the wide-open prairie, from Georgia pine forests to the high peaks of the Rockies.
#100-B-652164T 2.5-16x 42



Bushnell Magnetic Bore Sighter

Works on all calibers and firearms. Revolutionary design eliminates the need for arbors. Magnetically attaches to the muzzle to facilitate a quick sighting in. Etched glass reticle.
#100-B-740001C



Millett 1-4X24 DSM Designated Marksman Rifle Scope

The Designated Marksman Scope Reticle offers quick sighting under the most demanding conditions of close combat or dangerous game. The "Dot-in-a-Donut" aligns naturally to give accurate shot placement at ranges of 3 meters to 400 meters. Range measurement by use of the known scale of the donut is a simple matter.



The Designated Marksman Scope fills the requirements of the law enforcement officer, rifle shooter, and the big game hunter who needs a quick-sighting system at ranges of 5 yards to 500 yards. The "Dot-in-a-Donut" reticle allows for fast, natural aiming. The shooter's eye lines up the circle at close range, and the one MOA dot gives accuracy at the longer ranges. Range estimation is straight forward by use of the circle out to 500 yards. Compact design, 30mm tube, fully coated glass and bright illumination of the reticle are just a few of the many features of the DMS-1. Bright red illumination of the reticle adds to the quickness of the sighting system in day and low-light conditions. At 1 power it works well as a reflex sight and at longer ranges the 4X magnification gives increased accuracy
#100-B-BK81002



VISM Center Beam Series

Engineered with a Proprietary Internally Housed Laser Sighting System, the Center Beam Series Scopes provide a unique sighting experience for a multitude of applications such as S.W.A.T. CQB Situations, Eliminating pests on the farm, and Competing in 3 Gun Competitions. Years of Engineering Expertise and Innovative Cutting Edge Technology are the forefront of the new Center Beam Technology. Center Beam Series Scopes are available with a Red Laser or a Green Laser to suit the needs of even the most discriminating shooter.

Green Laser Scope Series
#111-VSM-VSFLGBM3942G 3-9x42 Mil-Dot Reticle
#111-VSM-VSFLGBP3942G 3-9x42 P4 Sniper Reticle

Red Laser Scope Series
#111-VSM-VSFLRBM3942G 3-9x42 Mil-Dot Reticle
#111-VSM-VSFLRBP3942G 3-9x42 P4 Sniper Reticle

Bushnell Elite 4200 Rifle Scope

Light him up. With the world's brightest riflescope, you're equipped to do so in the dimmest conditions. The fully multi-coated optics deliver an amazing 95% light transmission at 550NM. Our Rainguard HD anti-fog coating and FireFly reticle give you deadly command of your shot through any weather and every minute of legal time.
#100-B-42142M 1.25-4 x 24



Bushnell Trophy 3 MOA T Dot

Quickly help you distinguish between a brown tree and a brown critter, the Trophy riflescopes have been heralded by hunters as the ideal scope for the autumn deer woods. With multi-coated optics for increased brightness in low-light conditions, the avid inner hunter in you will be most satisfied.
#100-B-730132P 1 x 32mm MP Red Dot



Bushnell Trophy 3 MOA Red Dot

3 M.O.A. Red Dot
#100-B-731303 1x25 TRS-25



Millett TRS-1 4-16x50mm - Mil Dot Scope

Each TRS-1 has the Millett Mil-DotBar reticle that makes it easy to range and figure Mils. The brightness of the green reticle to a lower level on the illuminated reticle, giving a better low-light use.
#100-B-BK81001



Millett ZOOM Dot

The Millett Zoom Dot™ 30mm reflex sight is a non-magnifying 1-to-1 ratio red dot illuminated aiming system that can be used in all lighting situations with one or both eyes open.
#100-B-ZM00001 1X DOT REFLEX SYSTEM



VISM Vantage Series Category Summary

Expert Engineering has lead to the creation of some of the most advanced optics to hit the market. Vantage Series Scopes incorporate the High Performance Features that shooters have asked for such as Ultra Bright Optics for a crystal clear view and Positive adjustments to keep your shots on target. Whether you're hunting white tail deer in the Rockies, protecting our nation's citizens from hostile threat, or competing for the gold the Vantage Series has a scope that is right for you.



#111-VSM-VSFBM432G 4x32 Mil-Dot Reticle
#111-VSM-VSFBP432G 4x32 P4 Sniper Reticle
#111-VSM-VSFBR432G 4x32 Rangefinder Reticle
#111-VSM-VSFBM642G 6x42 Mil-Dot Reticle
#111-VSM-VSFBP642G 6x42 P4 Sniper Reticle
#111-VSM-VSFBR642G 6x42 Rangefinder Reticle
#111-VSM-VSFBP3940G 3-9x40 P4 Sniper Reticle
#111-VSM-VSFBM1042G 10x42 Mil-Dot Reticle
#111-VSM-VSFBP1042G 10x42 P4 Sniper Reticle
#111-VSM-VSFBR1042G 10x42 Rangefinder Reticle
#111-VSM-VSEFBP1042G 10x42 P4 Sniper Illuminated Reticle
#111-VSM-VSFBP41642G 4-16x42 P4 Sniper Reticle

4x32 Mil-Dot Reticle
 4x32 P4 Sniper Reticle
 4x32 Rangefinder Reticle
 6x42 Mil-Dot Reticle
 6x42 P4 Sniper Reticle
 6x42 Rangefinder Reticle
 3-9x40 P4 Sniper Reticle
 10x42 Mil-Dot Reticle
 10x42 P4 Sniper Reticle
 10x42 Rangefinder Reticle
 10x42 P4 Sniper Illuminated Reticle
 4-16x42 P4 Sniper Reticle



NcStar Mini Red Dot Sight

- Dot Size: 2 MOA
- Click Val: 1 MOA
- Integrated Weaver Style Mount

- #111-NCS-DDAB Black, Red Illuminated Reticle
- #111-NCS-DDAS Silver, Red Illuminated Reticle
- #111-NCS-DDAC Camo, Red Illuminated Reticle



NcStar Red Dot Sight

- Dot Size: 3 MOA
- Click Val: 1 MOA
- Integrated Weaver Style Mount

- #111-NCS-D4B Black, Red Illuminated Reticle
- #111-NCS-D4S Silver, Red Illuminated Reticle
- #111-NCS-D4C Camo, Red Illuminated Reticle
- #111-NCS-D4RGB Black, Red/Green Illuminated Reticle
- #111-NCS-D4RGS Silver, Red/Green Illuminated Reticle
- #111-NCS-D4RGC Camo, Red/Green Illuminated Reticle

NcStar MARK III 6-24X50 Scope

The Mark III was designed to give snipers, hunters, and target shooters features not found on average scopes.

- Illuminated reticle
- Magnification: 6x-24x
- Tube Dia. 30mm
- Objective Dia. (Mm) 50.00
- FOV (Feet At 100 Yards) 19.6-4.2
- Includes: Weaver Style Rings

- #111-NCS-SM3MAO62450G Reticle: Mil-Dot
- #111-NCS-SM3RAO62450G Rangefinder Reticle



NcStar Red Dot Sight w/ Integrated Laser

This new Red Dot falls right in line with Our Mark III Tactical Series with a similar exterior flow and the same great Lever-Locking Quick Release Weaver Style Mount.

- Magnification: 1x
- Objective Dia. (Mm) 40mm
- Integrated Weaver Quick Release Style

- #111-NCS-DLB140R Black Body



NcStar Pistolero Scopes

Offers long eye relief scopes in variety of power settings to satisfy the needs of just about any hunter, Target Shooter, and Professional Marksman. Designed for optimal function on pistols, scout rifles, or any other platform where long eye relief is needed. Serious shooters know that the NcStar Pistolero Series is right on target!

NcStar Pistolero 4X32 Scope

- Illuminated reticle
- Magnification: 4x
- Tube Dia. 1"
- Objective Dia. (Mm) 32.00
- Includes: Weaver Style Rings

- #111-NCS-SEPB432B Black Body
- #111-NCS-SEPS432B Silver Body



NcStar Pistolero 2X-7X32 Scope

- Illuminated reticle
- Magnification: 2x-7x
- Tube Dia. 1"
- Objective Dia. (Mm) 32.00
- Includes: Weaver Style Rings

- #111-NCS-SEPB2732B Black Body
- #111-NCS-SEPS2732B Silver Body



NcStar Pistolero 2.75x22 Scout Scope

- Magnification: 2.75x
- Tube Dia. 30mm
- Objective Dia. (Mm) 22mm
- Includes: Weaver Style Rings

- #111-NCS-SSB27522G Black Body



NcStar 1.25-4X32 Tactical Rifle Scopes

The Mark III Tactical Series 1.25-4x32 Compact Riflescope is infused with two distinct Quick Release options for either a standard Weaver style/picatinny rail or an AR/M16 carry handle.

- Magnification: 1.25x-4x
- Objective Dia. (Mm) 32mm
- Integrated Weaver Quick Release Style

- #111-NCS-STM125432G Black Body



NcStar 3-9x42 Tactical Scope w/ Integrated Laser

- Magnification: 3-9x
- Objective Dia. (Mm) 42mm
- Integrated Weaver Quick Release Style

- #111-NCS-SRTM3942G Black Rubber Body



NcStar Red and Green Laser Sight

Red and Green Laser Sight with Weaver Base and Pressure Switch APRLSRG offers the ability to easily switch from a red beam or green beam and back, with a simple flip of the bezel mounted option switch.

- Red Laser Beam: 635-655nm Red Laser Beam <5mw
- Green Laser Beam: 532nm Green Laser Beam <5mw

- #111-NCS-APRLSRG



NcStar Green Laser Sight

- 532nm Green Laser Beam <5mw
- Specially designed Weaver style mount with mounting tool
- Momentary & constant on/off cap switch and coil pressure switch included

- Powered by 1 CR123A Lithium Type Battery (included)

- #11-NCS-APRLSG

Scopelink S.T.A.R. Scope Tube Accessory Rail

- #SLR-SMS-001



Scopelink S.T.A.R. Double Rail Scope Ring

- #SLR-SMS-002

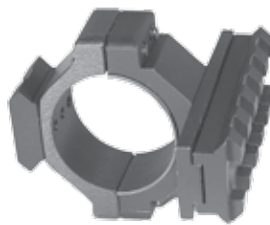

Scopelink S.T.A.R. Scope Tube Accessory Rail Show with ASLI

- #SLR-SMS-003



ACD - Anti-CANT Device

The patented ACD (Anti-CANT Device) is a simple spirit level mounted in an aircraft-quality, two-piece aluminum scope rings that mounts in minute without special tools. Properly mounted, the ACD allows the shooter to visualize and make adjustments for CANT, which experienced shooters recognize as rotation of a scope's crosshairs off a true vertical/horizontal plane. According to the Marine Corps Sniper Manual, compensating for CANT is critical to accurate long-distance shooting: At 1000 yards, 6 degrees of CANT (visualized as 1 minute on the face of a wristwatch) moves the bullet strike 55 inches from point of aim.

Weekend shooters who find varmints a challenge at several hundred yards are no less immune to CANT: 6 degrees of CANT at 100 yards gives the critters a new lease on life by a full 1/2 inch. Installed on a properly mounted rifle or pistol scope, the ACD uniquely equips the shooter to visualize and eliminate CANT with 100% certainty, 100% of the time.

The ACD has been extensively tested on rifles (does not require modification to the firearm or scope) and has stood up to heavy repeated recoil without shifting or detaching. Accuracy is within one-eighth of a degree. Mounts in minutes and can be placed either on top or below the scope, whichever is most comfortable for you and where it can be observed by the non-sighting eye.



- Eliminates 100% of CANT
- Accurate to within 1/8th of a degree
- Stands up to heaviest recoil
- Attaches in minutes without special tools
- No modification to scope or rifle required
- Works equally well on pistols or rifles
- Matches finish on most scopes
- Weighs less than 1/2 ounce
- Comes with complete instructions

- #LOP-A10-010 1" Black
- #LOP-A10-020 1" Silver
- #LOP-A30-010 30mm Black
- #LOP-A30-020 30mm Silver
- #LOP-A34-010 34mm Black
- #LOP-A35-010 35mm Black

Horus Vision ASLI

Angle Slope Level Indicator

The ASLI gives the sophisticated marksman a slope indicator and cant indicator in one hermetical-sealed unit. Its slope indicator eliminates guesswork in uphill and downhill shots by helping you find true level/ground distance: simply multiply the range to the target by the cosine value shown on the slope indicator. The cant indicator is invaluable in long-distance shooting: it helps keep bullet flight true to your sighted aim. The ASLI attaches directly to your scope, is reversible to accommodate left and right handed users, doesn't need batteries, and comes with a hard rubber cap.

- #HV-ASLI-30 30mm Ring Mount
- #HV-ASLI-34 34mm Ring Mount
- #HV-ASLI-SR Side Rail Mount
- #HV-ASLI 1" Ring Mount



Vortex Bubble Level

For the most precise long-range shooting, use the bubble level to ensure that the rifle is perfectly vertical. This will eliminate potential error caused by shooting a canted rifle. Mounts quickly and easily to the riflescope tube.

- #115-V-RAC-VT-BL3 30mm Tubes



Nightforce Angle Degree Indicator

Takes the guesswork out of uphill and downhill shots. Calibrated in degrees, it gives you an instant readout which you can enter directly into the Nightforce ballistic software program on your pocket PC or use with a pre-printed angle drop chart. The two-piece low-profile Picatinny mount design allows easy installation without removing your scope.

- #117-NF-ADIMT-R



Nightforce Anti-Cant Device Top Ring Level

This anti cant device from Nightforce features a bubble level to show the shooter if they are canting to the left or right. The device is only for use with the Nightforce Unimount, Direct Mount or Steel Rings.

- #117-NF-BAPLVL



RIANOV

Range Finding/Ballistic Calculator Measures targets to determine range and calculates Ballistic Solution

The RIANOV™ brings the power of Optical Ranging and the flexibility of MILDOT and simulated MILDOT Ranging to any scope. With Barometric Pressure and Temperature monitoring and compensation built in, the shooter stays focused down range on the target. Delivering first shot accuracy like no other.

User Benefits:

- Rapid Ballistic Solutions - Temperature and Barometric Pressure compensated using your DOPE Table in < 5 seconds
- No need for Pressure, Humidity or Temperature offset charts
- Important information on the display when needed
- Back Light LCD suitable for all lighting conditions
- Long Battery Life - More than 6 months of typical usage using a single CR-123A battery
- Computer link via USB to upload weapon system and DOPE Table information
- No impact to weapon zero settings
- Mounts in under 5 minutes to your rail or your scope
- Pre-Loaded with 1,600+ Unique bullet types ready to use with the Ballistics Calculator
- Light weight - 2.8oz (80 Grams)
- Small size

Multiple Modes of Operation

- Measure All** - Measure the Size of Target, capture the Slope angle and Cant angle of the rifle and allow the RIANOV™ to calculate the compensated Ballistic Solution
- Measure Slope + MILS** - Capture the Slope angle and Cant angle of the rifle, enter the MILS and allow the RIANOV™ to calculate the compensated Ballistic Solution
- Measure Slope + Range** - Capture the Slope angle and Cant angle of the rifle, enter the Range and allow the RIANOV™ to calculate the compensated Ballistic Solution
- Enter Slope & MILS** - Enter the Slope and MILS information and allow the RIANOV™ to calculate the compensated Ballistic Solution
- Enter Slope & Range** - Enter the Slope and Range information and allow the RIANOV™ to calculate the compensated Ballistic Solution

- #120-M06 Range Finding/Ballistic Calculator Measures targets to determine range and calculates Ballistic Solution
- #120-D06 MILDOT Ranging/Ballistic Calculator ONLY





Vortex Viper R/T 8x28 Tactical Binoculars

Combat to couz deer, the Viper R/T tactical binocular combines award-winning optics and required military features to create a tough, durable roof prism binocular-reliable in the worst conditions.

#115-V-V105RT

Vortex Viper R/T 10x50 Tactical Binoculars

Combat to couz deer, the Viper R/T tactical binocular combines award-winning optics and required military features to create a tough, durable roof prism binocular-reliable in the worst conditions.

#115-V-V105RT



Vortex Diamondback Roof Prism Binoculars

Superior quality, high-performance hunting optics can find their way around your neck for a surprisingly affordable price.

#115-V-D5085 8.5x50

#115-V-D5010 10x50



Vortex Recon R/T 15x50 Tactical Scope with VMS Kit

Rock solid stability in the field

The Recon R/T is a unique, advanced tactical piece of equipment that is unlike any other in the field the first truly compact, full-featured spotting scope developed especially for field surveillance and range estimating. The quick-handling, lightweight design features brilliant optical performance using Vortex premium XD glass and XR lens coatings. Featuring a unique modular design with Picatinny rails, the Recon R/T permits use with an almost unlimited number of accessories; the versatile attachment clip secures the Recon R/T to any belt or strap for rapid deployment. The R/T ranging reticle using mrad-based subtensions also includes a secondary quick-ranging system based on a human silhouette.

#15-V-RT155-VMS

NcStar Binocular Features

- Multi coated lenses
- Center focus sealed controls
- External control lever for instant zoom capabilities
- Nitrogen filled and O-ring sealed
- Tripod adapter compatible
- Includes soft carry case, neck strap, and lens caps

NcStar 7x-21x Binoculars

- Magnification: 7x-21x
- Objective Dia.(mm): 40.00
- FOV at 1000 yds: 295 feet

#111-NCS-BZ72140R



NcStar 10x-30x Binoculars

- Magnification: 10x-30x
- Objective Dia.(mm): 50.00
- FOV at 1000 yds: 236 feet

#111-NCS BZ103050R



NcStar 12x-40x Binoculars

- Magnification: 12x-40x
- Objective Dia.(mm): 70.00
- FOV at 1000 yds: 187 feet

#111-NCS-BZ124070R



Vortex Solo R/T 8x36 Tactical Monocular RANGING RETICLE

Built to be carried as a standard piece of equipment and close-at-hand, the Solo R/T tactical monocular gives you a closer look when you need it. Features the Vortex R/T Ranging reticle for accurate range estimation of targets and calling shots. And with the integral carry clip, the Solo R/T attaches securely to any belt, strap or webbing. Premium roof prism and fully multi-coated glass surfaces deliver bright images in a compact, lightweight, and easy-to-handle unit. Flared, fold-down rubber eyecup blocks stray light.



Vortex Solo 8x36 Tactical Monocular

Built to be carried as a standard piece of equipment, close-at-hand, the Solo monocular gives you a closer look when you need it. And with the integral carry clip, the Solo attaches securely to any belt, strap or webbing. Premium roof prism and fully multi-coated glass surfaces deliver bright images in a compact, lightweight, and easy-to-handle unit.



Bushnell H2O Folding Binocular

The H2O™ series binoculars are O-ring sealed and nitrogen purged to completely lock out moisture should you spill, take one overboard, or simply run into foul weather along the way. Rubber armoring with textured pads gives you a grip in slippery situations. Multi-coated optics and premium quality BaK-4 prism glass maximize light transmission and image clarity. You'll quickly see how a little planning on our part goes a long way to magnify your adventures on and around the water.

#100-B-130805 8x25 Folding Binoculars



NcStar Binocular Tripod Adapter

- Binocular Tripod Adapter fits most Binoculars with Threaded Center Frames
- Eliminates Hand Fatigue while keeping Binoculars Steady

#111-NCS-ABAP



NcStar 10x Spy Monoculars

- Magnification: 10x
- Objective Dia.(mm): 21.00
- FOV At 1000 Yds: 342 Feet

#111-NCS-NSB1021R



NcStar 10x Monoculars

- Magnification: 10x
- Objective Dia.(mm): 25.00
- FOV at 1000 yds: 331 Feet
- Lens Coating: Blue

#111-NCS-NG1025B



NcStar 12x Monoculars

- Magnification: 12x
- Objective Dia.(mm): 25.00
- FOV at 1000 Yds: 285 Feet

#111-NCS-N1225R

Black
Camo



NcStar 8x Monoculars

- Magnification: 8x
- Objective Dia.(mm): 21.00
- FOV at 1000 yds: 400 feet

#111-NCS-N821R



NcStar 10x Monoculars

- Magnification: 10x
- Objective Dia.(mm): 25.00
- FOV at 1000 Yds: 331 Feet
- Lens Coating: Ruby

#111-NCS-N1025R





Vortex Nomad 20-60x60 Spotting Scope

Our Nomad spotting scope is a heavyweight performer in a light, compact package. Perfect for use whenever space is at a premium. The rugged, waterproof, impact-resistant construction stands up to rough use in the field. The angled eyepiece design permits lower scope mounting height, which allows better stability and user comfort. Any way you look at it, the Nomad is simply a great all-round spotting scope in a trim package.

#115-V-NMD-60A

Bushnell Trophy Spotting Scope

Bushnell's Trophy series spotting scopes are built for people who know how demanding rugged, high-country hunting can be. 100% waterproof design and rubber-armored exterior combine for the ultimate in durability. Porro prisms and premium multicoated optics deliver a bright, clear picture. Each of the new models in this series includes a compact tripod, hard-side case and soft-side case.

#100-B-782065 20-60x65mm



Bushnell Excursion FLP Spotting Scope

The ultimate fusion of portability and powerful viewing capability, our waterproof, fogproof excursion spotting scope features a compact folded light path design and ED Prime Extra-Low Dispersion glass. ED Prime Extra-Low Dispersion glass delivers amazing color resolution and contrast, and virtually eliminates chromatic aberration and color-fringing to bring out the most distinct details possible in low-light conditions. Expect outstanding detailed, color-true viewing from first to last light.

#100-B-781569ED 15-45x60mm



NcStar 15x-40x Spotting Scope

- Magnification: 15x-40x
- Objective Dia.(mm): 50.00
- FOV At 1000 Yds: 150-45 Feet

#111-NCS-NG154050G



NcStar 30x-90x Spotting Scope With Tripod

- Magnification: 30x-90x
- Objective Dia.(mm): 90.00
- FOV At 1000 Yds: 78-33 Feet

#111-NCS-NB309090G



NcStar 20x-60x Spotting Scope With Laser & Tripod

- Magnification: 20x-60x
- Objective Dia.(mm): 60.00
- FOV At 1000 Yds: 114-51 Feet

#111-NCS-NB206060G



Coming Soon – The Optics Tree

Ever wanted to use a spotting scope or camera but didn't have a mount to hold it steady? Ever wanted to use two optics devices simultaneously but couldn't hold both? Ever wanted to place an optical device in one location, but view remotely from a separate location?

The Mounting Solutions Plus Optics Tree is the answer to problems about securely deploying optical devices.

- With three different mounts, the Optics Tree can be securely clamped to almost any surface (shooting benches, walls, fence posts, trailer hitches – literally any stable surface), both horizontal and vertical, regardless of thickness, or mounted on a collapsible tripod if ground is level.
- With different height adjustments, the Optics Tree allows deployment at a height of just a few inches or at the user's standing height.
- With complete three axis adjustments, the Optics Tree allows any optical device to be securely aimed in any direction.
- The optics tree allows multiple devices to be simultaneously mounted and adjusted, permitting almost optics combination to be used at the same time (spotting scopes, video cameras, still cameras, spotlights, I/R lights, etc.)

The uses for the Optic Tree are limited only by the user's imagination:

Military or law enforcement operators can set up surveillance locations equipped with standard cameras, I/R cameras, thermal imaging units, and night vision cameras, clamp the units onto any surface, set up a wireless feed to a command facility, and move to the next location to set up more units.

Shooters can set up multiple spotting scopes or ranging devices, clamped to any stable surface. Birdwatchers can set up spotting scopes and still or video cameras. Hunters can set up scopes for day or night vision or I/R devices for night viewing of game. What use do you have for the Optics Tree????



Optional Tripod Model

NcStar 800 Laser Rangefinders

- Extremely light weight and compact
- Ability to range objects from 12 to 800 yards
- Rugged Outer Shell
- Water Resistant design
- Measures in Yards or Meters

#111-NCS-NLB800



Bushnell Scout 1000 ARC Laser Rangefinder

A single button does the math. Just squeeze the trigger. Amazingly compact and simple to use, our new Scout 1000 with ARC figures distance based on terrain angle to give you an accurate "shoots-like" distance to 1,000 yards.

#100-B-201932 Yardage Pro 5x24



Nightforce Lens Cleaning Kit

The Nightforce Lens Cleaning Kit is ideal for cleaning the lenses on your Nightforce rifle scope. It includes a special lens brush for gently moving away large particles of dust and dirt, a microfiber cleaning cloth and an anti-fog cleaning solution. All of this comes packed in a hard plastic storage case.

#117-NF-CLKIT



McNETT OpDrops Anti-Fog & Lens Cleaning System

OpDrops™ Anti-Fog and Lens Cleaner provides clear, fog-free viewing for all types of lenses. To use, simply apply OpDrops to the lens and use the handy microfiber cleaning cloth bag to buff until clear. Op Drops is ideal for all types of lenses and eyewear including eyeglasses, sunglasses, binoculars and telescopes. Also ideal for sports and safety eyewear. Alcohol-free formula is safe on virtually all lens coatings.

#MCN-40725-AFS



McNETT Micro Fiber Towel

McNett MicroNet Advanced Microfiber's specially engineered, high density knit fabric is a highly compactable, super absorbent material with absolutely unique water absorption and cleaning properties. The ultra-fine .2 denier microfiber weave dries quickly-90% of water is removed with hand wringing. MicroNet microfiber towels properties and luxuriant feel are ideal for the discriminating travel, outdoor and watersports enthusiast. The handy carrying bag has a mesh front and waterproof backing

- Microfiber Towel Size Chart
- Incredibly small packed size fits easily into a backpack, travel pack or luggage.
 - Super absorbent—holds up to 5 times its weight in water.
 - Fast and easy drying—hand wringing removes almost all water and provides fastest dry time.
 - Includes convenient hanging loop.
 - Microfiber weave dries faster than regular towels.
 - No special laundering required.

- #MCN-68065-MC Coyote Med. Towel
- #MCN-68066-LC Coyote Large Towel
- #MCN-68067-XLC Coyote X-Large Towel
- #MCN-68055-MOD Olive Drab Med Towel
- #MCN-68056-LOD Olive Drab Large Towel
- #MCN-68057-XLOD Olive Drab X-Large Towel



Champion Precision Official NRA Targets

Champion® offers several official NRA targets on tagboard or paper. They include competition, silhouette, police pistol, training and qualification. Police pistol targets come in 20-50 foot slow fire, timed, and rapid fire. Training targets range from practice to advanced qualification.

25 yd. Slow Fire

Dimensions of this target are one-half the dimensions of the B-6, 50 yard Slow Fire pistol target. Slow fire scores on this target closely approximate the average slow fire scores at 50 yards.
Size: 10.5" x 12" paper
#105-CHP-40749 12 Pack
#105-CHP-40722 100 Pack



50 yd. Small Bore Rifle (Single Bull)

Official in all dimensions but used for practice only. Five to ten count - 8-9-10 rings black - Size: 7" x 9" paper.
#105-CHP-40759 12 Pack
#105-CHP-40773 100 Pack

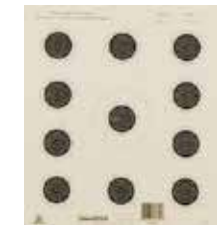

50 ft. Gallery Rifle

This is the official standard target for 50 foot gallery rifle shooting. Ten scoring bulls - one sighting-in bull - 6-7-8-9-10 rings black - Size: 10.5" x 12" tagboard.
#105-CHP-40744 12 Pack

100 yd. Scope Sighting-In

Center crosshairs on dot between four black squares. Not official. Size: 14" x 14" tagboard.
#105-CHP-40746 12 Pack
#105-CHP-40741 100 Pack



In-Sight Targets

For precision shooting, the Insight Target series provide high-contrast colors and designs to facilitate concentration and accuracy. Designed for small bore, rifle and pistol shooting, they are precise targets for the meticulous shooter.



50 yd. Small Bore Rifle
#105-CHP-45783 12 Pack

100 yd. Small Bore Rifle 14"x18"
#105-CHP-45784 12 Pack



100 yd. Rifle Sight In 14"x18"
#105-CHP-45785 12 Pack

25 yd. Pistol Slow Fire 11"x16"
#105-CHP-45786 12 Pack



Hoppe's Bullseye Dots

Aim small, miss small. These stick-on dots will pinpoint the way to better groups and scores. For target practice with slug shotguns/pistols.
#100-HP-DOT2 Size: 1" and 2". 35ea/pack.

25 yd. Timed & Rapid Fire

Size: 10.5" x 10.5" paper
#105-CHP-40753 12 Pack



50 ft. Timed & Rapid Fire

Official 50 ft. timed and rapid fire pistol target. Competition specifications. 9-10 rings black - Size: 10.5" x 12" tagboard
#105-CHP-40751 12 Pack



50 yd. Small Bore Rifle (Double Bull)

Official in all dimensions but used for practice only. Same bulls as A-23. 2 bulls - 7-8-9-10 rings black - Size: 14" x 9" paper
#105-CHP-40760 12 Pack
#105-CHP-40774 100 Pack



100 yd. Small Bore Rifle (Single Bull)

Official in all dimensions but used for practice only. Single 8" bull - 7-8-9-10 rings black - Size: 14" x 14" paper
#105-CHP-40762 12 Pack
#105-CHP-40777 100 Pack



LE Targets

These two additions to the Champion police target lineup are perfect additions to any law enforcement training program or those interested in some home defense target practice. Produced in the most popular designs, these large 23" x 36" targets offer realistic vital zone recognition and provide positive shot placement feedback that is sure to improve your shooting skills. Anatomically correct vital zone depiction provides the ultimate in paper target scenarios.

Features & Benefits

- Large 23" x 36" targets
- High contrast vital zone for exact shot placement
- Ideal for law enforcement or home defense practice

#105-CHP-40731 LE paper target - anatomy, 100 pack

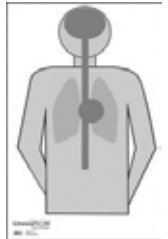

Police Silhouette Target

Black silhouette target on light background. Size 24" x 45"
#105-CHP-40727 Black Police Silhouette Target, 100 Pack



Police Silhouette Target

Blue Silhouette target area on light background. Size: 22.5" x 35"
#105-CHP-45759 25 yd. Police Silhouette Target, 100 Pack



Champion Staple Gun

Keep your paper targets securely in place with the Champion® Staple Gun. This compact staple gun easily slips into a shooting bag and ensures your paper targets remain up and ready for action. Constructed of durable steel and using JT21® staples, this is the "other" important gun you need to take to the range.
#105-CHP-45790



Adhesive Tape Rule

131-LJ-Tape





AmeriGlo Color Light Sticks 6"

Used by military, law enforcement, paramedics, campers, hikers, scouts, utility companies, hotels, schools, boaters, and well-prepared individuals.

- Safe & dependable to use
- Meets military specifications
- Ideal for long-term storage - up to 4 years
- Manufactured in an ISO 9002 certified facility
- Various colors and sizes
- Provides up to 12 hours of useable light
- Complies with defense logistics NSN standards

AmeriGlo 6" light stick is always individually foil wrapped to insure bright and dependable light when needed.



AmeriGlo 10" Safety Light Sticks Single with Multi-Position Bi-Pod

Bright 2 hour illumination with no heat, no flame and no spark. AmeriGlo™ Light Sticks are dependable safe for emergency lighting almost anywhere and anytime.

- Accident Scenes
 - Safety Light Sticks
 - Safe and easy to use
 - Visible up to one mile
 - No smoke, no flame
- Traffic Checkpoints
 - Establish lanes
 - Increase officer safety
 - Highly visible
- Landing Zones
 - Mark perimeter
 - Establish runaway
- Search & Rescue
 - Trail marking
 - Evidence marking
 - Personal identification
 - Scuba Diving

#AGL-1002-HL
Lime Green Two-Hour Stick

#AGL-1002-HY
Yellow Two-Hour Stick

#AGL-1002-HR
Red Two-Hour Stick



USE INSTEAD OF FLARES...
NO FIRE RISK!
WIRE STAND INCLUDED

Twelve Hour Light Sticks



Eight Hour Light Sticks



Magnetic base holder

For Lightstick. Screw in fitting and powerful magnetic base allows for all position on metal objects.

#AGL-LSA-002



Lightstick clip on holder

With swivel aperture shield for on/off option and directional viewing.

#AGL-LSA-001



Lazer-Stik Battery Powered Marker

The Lazer-Stik is a replacement for chemical light sticks and it can be ordered in either a steady-on or flashing version. The Lazer-Stik works in temperatures where light sticks cannot. This light is reusable, environmentally friendly, and very reliable. The light has a long shelf life, outlasts chemical lights, and even floats upright. Of course, this light can also be turned on and off!

- #KNV-18000 Yellow Steady On 8" Lazer-Stik
- #KNV-18001 Red Steady On 8" Lazer-Stik
- #KNV-18002 Blue Steady On 8" Lazer-Stik
- #KNV-18003 Green Steady On 8" Lazer-Stik
- #KNV-18004 White Steady On 8" Lazer-Stik

White Single 6" Lightstick
#AGL-000-W01

White 10 Piece - 6" Lightsticks
#AGL-000-W10

Green Single 6" Lightstick
#AGL-109-G01

Green 10 Piece 6" Lightsticks
#AGL-109-G10

Yellow Single 6" Lightstick
#AGL-208-Y01

Yellow 10 Piece 6" Lightsticks
#AGL-205-Y10

Infra-Red Single 6" Lightstick
#AGL-209-I01

Infra-Red 10 Piece 6" Lightsticks
#AGL-209-I10

Red Single 6" Lightstick
#AGL-307-R01

Red 10 Piece 6" Lightsticks
#AGL-307-R10

Blue Single 6" Lightstick
#AGL-406-B01

Blue 10 Piece 6" Lightsticks
#AGL-406-B10

Orange Single 6" Lightstick
#AGL-505-O01

Orange 10 Piece 6" Lightsticks
#AGL-505-O10

Counter Display 30 Piece (15Y-15G) 6" Lightsticks
#AGL-407-O30

Trial Pack (2Y-2G-1R-1B)
#AGL-TRL-006

10 Green-10 Red 6" Lightsticks
#AGL-TRL-020

5 Green-5 Red-5 Blue-5 Yellow 6" Lightsticks
#AGL-TRL-20A

10 Green, Red, Blue, Yellow 6" Lightsticks
#AGL-TRL-040

50 Green - 50 Yellow 6" Lightsticks
#AGL-TRL-100



SureFire E2D Executive Defender

Compact, high-intensity incandescent, tactical-level incandescent flashlight with enhanced self-defense features.

Max Output: 60 lumens
Runtime: 1.25 hours
#SUR-E2D-BK

SureFire E2D LED Defender

Compact self-defense LED flashlight two outputs—high-output tactical-level lighting and low-output useful lighting.

Max Output: 5/120 lumens
Runtime: 76/1.9 hours, low/high settings
#SUR-E2DL-BK

SureFire E2L Outdoorsman

Compact dual-output LED with extended runtime for backpacking and general use.

Max Output: 3/60 lumens
Runtime: 100/11 hours low/high settings
#SUR-E2L-HA-WH

SureFire E2E Executive Elite

Incandescent. Compact, high-intensity incandescent flashlight for self-defense and general use.

Max Output: 60 lumens
Runtime: 1.25 hours
#SUR-E2E-BLK

SureFire M1 Infrared Illuminator

Battery-powered LED. Ultra compact extended runtime infrared (IR) LED flashlight for use with NVDs. Produce a smooth beam of invisible infrared light for use with night vision equipment.



#SUR-M1

SureFire L5 LumaMax

Compact, high-intensity LED flashlight for tactical, duty, and general use or conditions requiring an enhanced grip.

Max Output: 100 lumens
Runtime: 2 Hours
#SUR-L5-HA-WH



SureFire Filter & Covers

Slip-on filters

- #SUR-F03** F03 Infrared Filter 1.0" diameter bezel
- #SUR-F04** F04 Diffuser Filter 1.0" diameter bezel
- #SUR-F05** F05 Red Filter 1.0" diameter bezel
- #SUR-F06** F06 Blue Filter 1.0" diameter bezel
- #SUR-FM33** FM33 Infrared Filter 1.25" diameter bezel
- #SUR-FM34** FM34 Diffuser Filter 1.25" diameter bezel
- #SUR-FM35** FM35 Red Filter 1.25" diameter bezel
- #SUR-FM36** FM36 Blue Filter 1.25" diameter bezel
- #SUR-FM37** FM37 Beam Cover 1.25" diameter bezel
- #SUR-FM63** FM63 Infrared Filter 1.47" diameter bezel
- #SUR-FM64** FM64 Diffuser Filter .47" diameter bezel
- #SUR-FM65** FM65 Red Filter .47" diameter bezel
- #SUR-FM66** FM66 Blue Filter .47" diameter bezel
- #SUR-FM67** FM67 Beam Cover .47" diameter bezel

SureFire E1L Outdoorsman

Compact, dual-output LED with extended runtime for backpacking and general use.

Max Output: 3/45 lumens
Runtime: 48/8.5 hours, low/high settings
#SUR-E1L-HA-WH

SureFire E1B Backup

Ultra compact, dual-output LED with extended runtime, tactical-level light output.

Max Output: 80/5 lumens
Runtime: 1.3/37 hours
#SUR-E1B-BK-WH

SureFire E1E Executive Elite

Battery-powered incandescent. Ultra compact incandescent flashlight for everyday carry.

Max Output: 15 lumens
Runtime: 1.5 hours
#SUR-E1E-HA



SureFire G3 Nitrolon

Compact high-intensity incandescent flashlight for tactical, self-defense, and general use.

Max Output: 105/200 lumens
Runtime: 60/20 minutes
#SUR-G3-BLK

SureFire G3 LED

Compact LED flashlight featuring a super-efficient, high-output, long-running LED for tactical and general use.

Max Output: 80 lumens
Runtime: 9.42 hours (5.8 hrs tactical-level light)
#SUR-G3L-BLK

SureFire G2 Nitrolon

Compact high-intensity incandescent flashlight for tactical, self-defense, and general use.

Max Output: 65/120 lumens
Runtime: 60/20 minutes
#SUR-G2-BK

SureFire G2 LED

Compact LED flashlight featuring a super-efficient, high-output, for tactical, outdoor, and general use.

Max Output: 80 lumens
Runtime: 12 hours
#SUR-G2L-BLK Black
#SUR-G2L-OD Olive Drab

SureFire G2Z LED CombatLight

Compact LED flashlight featuring a high-output, long-running light emitting diode and an ergonomic CombatGrip™

Max Output: 80 lumens
Runtime: 12 hours
#SUR-G2Z-BK



SureFire SC3 Spares Carrier

This impact-resistant, watertight polymer container provides storage for one spare lamp assembly and four 123A Lithium batteries. Batteries and lamp not included



#SUR-SC1 Fits: P60, P61, P90, P91, R30, R60, MN01, MN02, MN03, MA02

#SUR-SC2 Fits: N1, N2, N4, N5, MN10, MN11, MN15, MN16, MN20, MN21, MN60, MN61, N62, MA02

#SUR-SC3 Fits: MN01, MN02, MN03, MA02

SureFire 9P Original

Compact, high-intensity incandescent flashlight for tactical, duty, and general use.

Max Output: 105
Runtime: 60 minutes
#SUR-9P-BK

SureFire 6P Original

Compact, high-intensity incandescent flashlight for tactical, self-defense, and general use.

Max Output: 65/120
Runtime: 60/20 minutes
#SUR-6PL-BLK

SureFire 6P LED

Compact flashlight featuring a super-efficient, high-output, long-running LED for tactical, outdoor, and general use.

Max Output: 80 lumens
Runtime: 11 hours
#SUR-6P-BLK

SureFire 6P Defender

Compact high-intensity incandescent flashlight for tactical, self-defense, and general use.

Max Output: 65/120 lumens
Runtime: 60/20 minutes
#SUR-6PD-DEFENDER

SureFire C3 Centurion

Compact, high-intensity incandescent flashlight for duty and tactical use or conditions requiring enhanced grip.

Max Output: 105/200 lumens
Runtime: 60/20 minutes
#SUR-C3-BLK

SureFire 123A Lithium Batteries

Optimized for use in SureFire flashlights, SureFire Lithium batteries pack a lot of power into a small package. And—unlike alkaline batteries, SureFire High-Performance Lithium Batteries boast a ten-year shelf life, which means they will be ready when you need them, every time.

For all SureFire Lithium battery powered lights.

- #SUR-SF6-BC** Box of 6 SureFire Batteries
- #SUR-SF12-BB** Box of 12 SureFire Batteries
- #SUR-SF72-BB** Box of 72 SureFire Batteries

SureFire MN02 Lamp Assembly

The MN02 lamp assembly fits in the 2-battery Executive series flashlights. The **MN02** produces 25 lumens of light for 2.5 hours, extending the runtime as compared to the MN03 lamp assembly, which produces 60 lumens for 1.25 hours.

Fits: E2, E2E, E2O
#SUR-MN-02 MN02
#SUR-MN-03 MN03



SureFire P60L LED/Reflector Assembly

LED reflector assembly that converts any SureFire flashlight that uses a P60, P61, P90, or P91 incandescent lamp assembly into a longer-running and higher-output when replacing a P60 lamp assembly

Max Output: 80 lumens
Runtime: 12 hours
#SUR-P60L Fits: 6P, 9P, C2, C3, D2, D3, G2, G3, G2Z, M2, Z2, Z3



SureFire P60 Lamp Reflector Assembly

The standard long life P60 Lamp Reflector Assembly

Max Output: 65 lumens
Runtime: 1 hours
#SUR-P60 Fits: 6P, C2, D2, G2, G2Z, M2, Z2

SureFire P90 Lamp Reflector Assembly

The standard long life P90 Lamp Reflector Assembly

Max Output: 100 lumens
Runtime: 1 hours
#SUR-P90 Fits: 9P, C3, D3, G3, Z3

SureFire V70 Holster

The patented V70 Speed Holster allows the user to quickly access the flashlight.

Fits: 6P, 6PD LED, 6PD, 6P LED, 9P, G2, G2 LED, G2Z, G2Z LED, G3, G3 LED, Z2, Z2 LED
#SUR-V70



SureFire KL5A LED Conversion Head

The KL5A LED conversion head provides your 6P, C2, G2, G2Z, M2, Z2 flashlights with the latest in high-intensity LED technology.

Max Output: 100 lumens
Runtime: 5 hours
#SUR-KL5A-HA-WH



SureFire Z49 Click-on Tailcap

Now you have a choice of Momentary or Constant-on light activation without having to rotate the tailcap of your light.

#SUR-Z49



SureFire KX1 LED Conversion Head

Converts a SureFire E1E incandescent flashlight into a higher-output, dual-output, longer-running LED flashlight.

Max Output: 45 lumens
Runtime: 40 hours
#SUR-KX1-HA-WH Fits: E1E and older model E1L with KL1 head



SureFire Z57 Click-on Tailcap Switch

Now you have a choice of momentary or constant-on light activation without having to rotate the tailcap of your light.

#SUR-Z57 Fits: E1E, E1L, E2D, E2D LED, E2E, E2L, E2O, L4



SureFire X300 LED Weapon Light

Solid-state, electronically regulated LED that generates 110 lumens of tactical-level light — enough to overwhelm an aggressor's night-adapted vision.

#SUR-X300

SureFire X400 LED WeaponLight w/ Laser

LED WeaponLight with an integrated red-laser sight mounted below its solid-state LED.

#SUR-X400

SureFire Saint Minimus - Headlamp

Saint Minimus is a virtually indestructible headlamp, just like Saint, but Minimus offers a lower profile and less weight. It's powered by one 123A Lithium battery that screws right into the housing utilizing Minimus's single-battery cap.

#SUR-HS2-A-BK



INOVA Color LED Flashlight

Primary LED: White;
Secondary LEDs: Red, Green, Blu
 With five high-performance, multi-programmable LEDs, it is the ligh for any situation. Among the virtu itless missions suitable for the IN Color flashlight are: a field light, close quarters battle, high-risk search, prisoner control, ground crew operations, fluid detection, target designation, and explosive detection and identification.

#INO-INF-BW125 Black



INOVA Inforce Color LED Flashlight

White LED
 The INFORCE White flashlight is designed to deliver precise lighting performance at three levels of light intensity. When required it can operate as a high-intensity signal/reconnaissance and navigation beacon, and has a built-in disorienting CQB strobe for use during search and entry engagements and operations.

#INO-INF-BC150 Black
#INO-INF-DC150 Desert



Fenix TK40, World's Brightest AA-powered Flashlight

The TK40 is the latest installment in the TK-Series and is the first Fenix to use Cree's MC-E quad-die, very powerful LED. Powered by eight AA batteries and boasting 630 lumens of output, the TK-40 is the ultimate portable, long-range illumination tool for the backpacker, explorer, and flashlight lover. The TK40 has two different modes of output, each with four different levels - a total of eight different outputs.

#102-FL-TK40-B

NcStar Laser and LED Flashlight

The NcStar Pistol and Rifle Mount Laser and 3W LED Flashlight Kit AQPFLS is constructed of hard anodized aluminum and reinforced nylon and ready to withstand even the toughest abuse.

• Flashlight Power: 120 lumens
 • Laser Power: 635-655nm <5mW

#111-NCS-AQPFLS



SureFire M952XM07 Mill

The M952XM07 is six-volt shock-isolated system powered by two lithium batteries with Throw-Lever Mount

Max Output: 65 /120 lumens
Runtime: 60/20 Minutes
#SUR-M952XM07

SureFire M961XM07 Mill.

Univ. WL, 9-Volt, 1.62" Head, Dual Thumbscrew Mount

Max Output: 65 /120 lumens
Runtime: 60/20 Minutes
#SUR-M961XM07

SureFire XT07 Remote Switch for X-Series WeaponLights



INOVA Inforce LED Flashlight Pressure Remote Switch

Vertical foregrip with remote pressure switch. Weapon mount with remote pressure switch, no vertical foregrip.

#INO-INF-BPS Black
#INO-INF-DPS Desert



INOVA Inforce LED Flashlight Weapon Mount

Quick release, easy "in-and-out."

#INO-INF-WM



The Fenix LD20 Flashlight

With its excellence in performance, quality, function as well as appearance, it is highly recommended to flashaholics.

#101-FL-LD20-B

Fenix Digital LD01 Q5 Keychain Light

The Fenix LD01 is extremely small, not much bigger than the AAA cell it uses. It has three modes: Medium -> Low -> High.

#102-FL-LD01-B

Rail Mount Z-5 LED Light

The most universal rail mount light, the Z-5. Your Z-5 will fit Weaver/Picatinny/Glock rail. 65 Lumens of light output / Xenon module from USA. Constant on/of switch or paused.

#LA-86105



Replacement Locking Bar



Locking Bar

Steel replacement locking bar for M-3 Tactical Lights.
#LLR-SLB-NR1



Streamlight Sidewinder with LED

Sidewinder, the most versatile military light in the world. Twenty flashlights in one! Each LED features 4 levels of output intensities: Low (5%), Medium (20%), Medium-High (50%), High (100%) plus a Strobe function (100%)

- One switch for On-Off, dimming and mode selection functions.

#101-SL-14002 Tan
#101-SL-14003 Olive Drab

Streamlight Sidewinder Compact

Super lightweight and versatile hands-free helmet light clips onto helmet or MOLLE in seconds.

#101-SL-14102 Tan
#101-SL-14103 Olive Drab

Streamlight Super Tac Flashlight with Vertical Grip & Rail

Streamlight now offers a cost effective means of mounting your Streamlight Super Tac

Constructed from machined aluminum, this Streamlight vertical foregrip has a hard anodized rail grabber with integral Picatinny rail and storage compartment for extra batteries.



Streamlight TLR-1 Tactical Flashlight

Intensely bright, virtually indestructible tactical light, attaches/detaches to almost any gun in seconds. Now featuring the latest C4 LED technology producing 2 to 3 times the output of previous LEDs.

#101-SL-69110

Streamlight TLR-2 Tactical Flashlight with Laser Sight

The same great features of the TLR-1 with an integrated laser sight for accurate aiming. Now with C4 LED Technology.

#101-SL-69120

Streamlight TLR-3 Compact Tactical Flashlight

Includes 5 interchangeable keys to fit a wide variety of weapons

#101-SL-69220

Streamlight 3V CR123 Lithium Batteries

- #101-SL-BAT4 Pack of 4
- #101-SL-BAT10 Pack of 10
- #101-SL-BAT24 Pack of 24
- #101-SL-BAT50 Pack of 50



Streamlight Polystinger LED Flashlight

A combination of rechargeability and LED technology that produces the lowest operating cost of any flashlight made! The new Stinger LED, with an ultra-bright, far-reaching beam.

#101-SL-76813

Streamlight Stinger DS LED Flashlight

Two switches are better than one! A powerful, long-running, long-lasting LED with all the same great features as the Stinger LED

#101-SL-75813

Streamlight Super Tac Flashlight

The Super Tac is an extremely high performance lithium battery-powered flashlight featuring latest in C4 LED technology for extreme brightness and long range illumination combined.

Streamlight Strion C4 LED Flashlight

Rechargeable, ultra-compact and powerful, the Strion LED offers three variable intensity modes, strobe mode and the latest in power LED technology.

#101-SL- 74301

Streamlight PolyTac

Introducing Streamlight's first virtually indestructible, super-bright, nylon polymer tactical light!

#101-SL-88800

Streamlight PolyTac LED

Introducing Streamlight's first virtually indestructible, super-bright, nylon polymer tactical light!

#101-SL-88850



NEBO CSI Investigator Color LED Flashlight & Laser

- 30 powerful LEDs provide superior light.
 - Anodized aluminum with a sleek black finish.
 - 5 Settings including a laser pointer, UV (black) light, 6 green, and flash mode.
 - 11 different modes when using both switches!
- #NEBO-5075

NEBO Super CSI Tactical LED Flashlight & Laser

- 10 Powerful Ultra Bright Leds
 - 5 Powerful Ultra Bright Green Leds
 - Red Laser Pointer
 - Emergency Flasher Function
 - Anti-roll Body Design
- #NEBO-5085

NEBO CSI Tactical LED Flashlight & Laser

- 8 Powerful Ultra Bright LEDs (96,000 MCD LED Light/110,000-plus bulb hour life)
 - Red Laser Pointer travels over 450 yards
 - Aggressive Self-Defense Face
- #NEBO-5067B

Nebo Edge 35 Mini Flashlight with Clip

- Powerful 35 Lumen LED - Just click the Rear Button 1 time for 35 Lumens of brightness (LED Bulb 110,000-plus hr. life)
- Aggressive Self-Defense Face - The aggressive design face can be used to defend yourself (please use caution when using flashlight)

NEBO CSI Bright LED Pocket Light

- 1 Powerful 35 Lumen LED
 - Aggressive Self-Defense Face
- #NEBO-5112



NEBO Protec Elite HP190

Uses a highly efficient CREE Q5 LED to generate 190 lumens of intense white light. Light of this magnitude is enough to dominate an aggressor's night adapted vision, ideal for military, law enforcement, and self-defense.

#NEBO-5569



NEBO Protec Elite HP230

Uses a highly efficient CREE Q5 LED to generate intense white light. Light of this magnitude is enough to dominate an aggressor's night adapted vision, ideal for military, law enforcement, and self-defense. The reflector lens focuses the beam for long distance lighting while also producing enough light to support the user's peripheral vision. The HP230's batteries will produce 3 hours of continuous illumination.

#NEBO-5567



Non-Recoil Protected Mount

Designed for accessories where recoil is not an issue.*
#LLR-NRP-000

Light-Recoil Protected Mount*

#LLR-RPR-LGH Designed for .223

Average-Recoil Protected Mount*

#LLR-RPR-AVE Designed for .308

Maximum-Recoil Protected Mount

#LLR-RPR-MAX Designed for .50 cal.

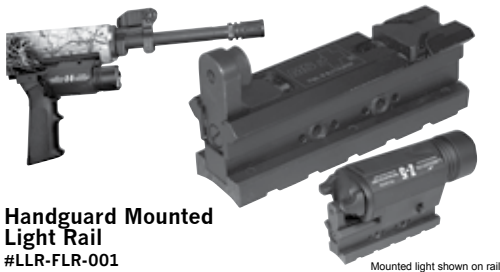

Handguard Mounted Light Rail

#LLR-FLR-001

TOP LIGHT by MSP

Head band with single rail mounted tactical light for hands free operation.

#LLR-00-HB1 Single Mount
#LLR-00-HB2 Double Mount



Helmet Mount

Instantly mounted fully adjustable tactical hands-free lighting. Snap the light off your weapon and on to your helmet.

#LLR-000-HM1



Tactical Light Velcro Mount

Attaches most rail mounted lights to any Velcro surface.

#LLR-LRM-002



Tactical Light Belt Loop Carrier

Safely store most rail mounted flashlights on your belt loop. Protected from accidentally being turned on.

#LLR-LRM-003



Round Accessory Mounts (Ram)

RAM adapters are now available to mount round accessories to a 1913 mil-spec Picatinny rail or Weaver rail. Flashlights, lasers, miniature camera bodies - literally any round accessory can now be instantly mounted or dismounted from any weapon system using RAM adapters.

RAM adapters are available in a variety of heights to accommodate almost any requirement, and need only a 1 inch clamping surface to mount. RAM adapters are available for both 1 inch and 30 mm accessories, and with use of simple bushings can be adapted to any other unique diameter accessory.

RAM adapters are light weight and have the lowest profile available - barely larger than the accessory. While light, RAM adapters use high strength steel thread inserts that won't strip no matter how tight the accessory is clamped.



	Height	Clearance Diameter
#105-WVR-SR-49032 1" Ring Low Silver	0.09	38mm
#105-WVR-SR-49033 1" Ring Med Silver,	0.19	40mm
#105-WVR-SR-49034 1" Ring High Silver,	0.35	44mm
#105-WVR-SR-49036 1" Ring XHigh Silver	0.55	50mm
#105-WVR-SR-49040 1" Ring Low Black	0.09	38mm
#105-WVR-SR-49041 1" Ring Med Black	0.19	40mm
#105-WVR-SR-49042 1" Ring High Black	0.33	44mm
#105-WVR-SR-49044 1" Ring XHigh Black	0.56	50mm
#105-WVR-SR-49120 30mm Ring Low Silver	0.29	46mm
#105-WVR-SR-49121 30mm Ring Med Silver	0.5	54mm
#105-WVR-SR-49130 30mm Ring High Black	0.29	46mm
#105-WVR-SR-49131 30mm Ring XHigh Black	0.5	54mm

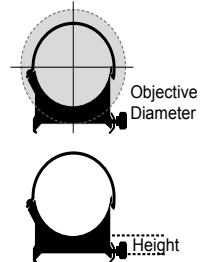

Tactical Light Arm Band Carrier

Light where your hands are working with MSP's rail mounting system.

#LLR-LRM-001



Nebo 5083 Quarrow 15 LED Headlamp Flashlight

- Flashlight with 15 LED - 10 White & 5 Green Head
 - Water Resistant
 - Headlamp ratchet allows for easy rotation to adjust the direction of the beam
 - 3 AAA Batteries Included
 - 3 Light Modes
 - 15 LEDs
- #NEBO-5083

Nebo 5435 Quarrow Vista 3 LED Headlamp Flashlight

- 50 Lumens
 - Glow in the dark power switch
 - 10 Hours burn time
 - Headlamp ratchet allows for easy rotation to adjust the direction of the beam
 - 3 AAA Batteries Included
 - 3 High powered LED Headlamps
- #NEBO-5435

B&W International Outdoor Case - Pistol Case

The outdoor.cases are watertight, dustproof, airtight, shock resistant, virtually indestructible, chemical resistant and corrosion proof. They are equipped with sturdy eyes for padlocks, an air pressure compensation valve. They are designed for temperatures ranging from -40° C to 80° C. They are made from Ultra-High-Impact ABS Plastic. Outdoor.cases are available in orange and black and with individual interior outfit (the standard outfit is empty). Unlimited Lifetime Guarantee.

- Case shells made of Ultra High-Impact ABS Plastic
- Air pressure compensation valve
- 2 locks
- Incl. carrying strap
- Temperatures ranging from -40° up to +80° C
- Very sturdy, stackable
- Dustproof, airtight, watertight
- Unlimited lifetime guarantee
- All Outdoor cases have a NATO Military compliance approval specification and number
- All have the ability to accept a shoulder strap built into each case
- Standard with either a customizable pick and pluck divider system or a reconfigurable padded divider.



- #114-BW-12008-B-SI Type 05 Black Pistol Case, 225 x 170 x 85 mm
- #114-BW-12008-O-SI Type 05 Orange Pistol Case, 225 x 170 x 85 mm
- #114-BW-12809-B Type 10 Black Pistol Case, 275 x 229 x 85 mm
- #114-BW-12809-O Type 10 Orange Pistol Case, 275 x 229 x 85 mm
- #114-BW-12816-B Type 20 Black Pistol Case, 275 x 225 x 155 mm
- #114-BW-12816-O Type 20 Orange Pistol Case, 275 x 225 x 155 mm
- #114-BW-13515-B Type 30 Black Pistol Case, 365 x 265 x 155 mm
- #114-BW-13515-O Type 30 Orange Pistol Case, 365 x 265 x 155 mm
- #114-BW-14016-B Type 40 Black Pistol Case, 410 x 325 x 165 mm
- #114-BW-14016-O Type 40 Orange Pistol Case, 410 x 325 x 165 mm
- #114-BW-18012-B-SI Type 72 Black Rifle Case, 1210 x 430 x 175 mm
- #114-BW-1282 Type 80 Black Ammo Case, 270 x 235 x 205 mm
- #114-BW-1382 Type 80 Black Ammo Case, 410 x 295 x 280 mm

Uncle Mike's Kydex Double Mag Cases

Now protect your magazines like you do your firearm. Choose from single or double cases.

- Fits belt loops up to 1 3/4".

- #100-UM-51361 Double Stack
- #100-UM-51371 Single Stack



Uncle Mike's Clip-On Tactical Light Holder

This holder accepts Insight Technology M-3, M-5 and M-6 lights, Glock lights, and some Sure-Fire models. Clips on to any dress or duty belt up to 2 1/4".

#100-UM-50301

Uncle Mike's Universal Holster w/ MOLLE System

- Quickly changes between light bearing and non-light bearing pistols
- Converts easily from right hand to left hand carry
- Works with versatile MOLLE system for placement anywhere on the body
- Can be mounted on any 1.75" and 2" duty style belt
- Fits most medium and large auto pistols
- Works with SureFire and Streamlight weapon-mounted lights
- Mounts on vest or Drop Leg Platform
- Traditional thumb break with secondary ITW-Ghiletex buckle strap for added retention

#100-UM-7702001



Uncle Mike's Modular Drop Leg Platform

Ingeniously designed platform gives you the ultimate flexibility and stability needed to mount and carry holsters and important accessories on a soft-sided, drop leg platform.

- A perfect choice for strong or offside carry
- MOLLE compatibility creates total flexibility
- Internal pocket can hold armor or other items
- Fully adjustable to fit any size leg

#100-UM-7702520



Uncle Mike's Kydex Gun Holsters with Paddle & Belt Loop

Kydex Paddle Holster attachment

Featuring an ultra-adjustable design, this paddle holster is soft, pliable and features air vents for the utmost in wearing ease.

- Drawing is easier because the body's lead edge is cut down
- Adjusts for rake and height to match your torso height and body type
- An excellent choice for both men and women

Kydex Belt Holsters attachment

It rides close to the body at a mid-level height.

- Nearly vertical rake for conventional behind-the-hip carry. Can be used as an appendix carry
- Cut-down lead edge aids in presentation of firearm
- Fits belts up to 1 3/4"



#ID	Size	Hand	Fit Information Belt Slide & Paddleline
#100-UM-54121	12	R	Glock 16, 27, 33 & other subcompact 9mm/.44 cal
#100-UM-54122	12	L	Glock 16, 27, 33 & other subcompact 9mm/.44 cal
#100-UM-54151	15	R	Ruger P85, P89, P90, P91
#100-UM-54152	15	L	Ruger P85, P89, P90, P91
#100-UM-54161	16	R	Ruger P93, P94, P95, P97
#100-UM-54171	17	R	S&W M&P
#100-UM-54172	17	L	S&W M&P
#100-UM-54181	18	R	S&W 5900 & Certain 4000 Series
#100-UM-54182	18	L	S&W 5900 & Certain 4000 Series
#100-UM-54191	19	R	Up to 5" bbl 1911 Types
#100-UM-54192	19	L	Up to 5" bbl 1911 Types
#100-UM-54201	20	R	Most Beretta 92 & 96 Models
#100-UM-54202	20	L	Most Beretta 92 & 96 Models
#100-UM-54211	21	R	Glock 17, 22, 19, 23
#100-UM-54212	21	L	Glock 17, 22, 19, 23
#100-UM-54221	22	R	SIGARMS 220, 226
#100-UM-54222	22	L	SIGARMS 220, 226
#100-UM-54231	23	R	SIGRRAMS Pro 2340
#100-UM-54232	23	L	SIGRRAMS Pro 2340
#100-UM-54241	24	R	SIGRAMS 225, 245, 228, 229
#100-UM-54242	24	L	SIGRAMS 225, 245, 228, 229
#100-UM-54251	25	R	Glock 21, 20
#100-UM-54252	25	L	Glock 21, 20
#100-UM-54261	26	R	Springfield XD - Full Size
#100-UM-54262	26	L	Springfield XD - Full Size
#100-UM-54271	27	R	Springfield XD - Compact
#100-UM-54272	27	L	Springfield XD - Compact
#100-UM-54291	29	R	Walter P99/SW99 Full Size & Compact
#100-UM-54292	29	L	Walter P99/SW99 Full Size & Compact
#100-UM-54301	30	R	HK USP Full Size
#100-UM-54302	30	L	HK USP Full Size
#100-UM-54311	31	R	HK USP Compact (all calibers)
#100-UM-54312	31	L	HK USP Compact (all calibers)
#100-UM-54361	36	R	S&W J Frame 38/357 up to 2 1/8" barrel
#100-UM-54362	36	L	S&W J Frame 38/357 up to 2 1/8" barrel

Uncle Mike's Deluxe Range Bag

Simply the ultimate range bag - developed by shooters for shooters.

- Easy entry, a roll-up double-zippered flap with hook-and-loop fastener closes main compartment
- Easy carry - Shoulder strap with quick-release buckles and two web handles
- Protective - Padded pistol rug included with two lockable side compartments, plus a thickly padded compartment

Main compartment is 15" wide x 9" high x 7" deep (381 x 229 x 178 mm)

#100-UM-52411



(Contents not included)

Uncle Mike's Field Bag

- Roomy carry bag with removable hard bottom and dual zippers.
- External pouches at both ends-one with a zippered compartment for carrying I.D.
- Large front and rear external zippered compartments; front has divider.
- Three-sided zipper on main compartment allows full access while keeping bag upright.
- Wrap-around web handle and removable shoulder strap.
- Lockable zippers.

Dimensions: Center is 10" w x 20 1/2" l x 12" h

#100-UM-52481



Uncle Mike's Wheeled Duffle Bag, Black

If you're going out into the field for an extended time, you'll need a bag with this much carry room to get you there. And because it's on wheels, you won't be straining your back to get all your gear there.

- Huge center compartment and padded top-end compartment. Two full-length zippered side compartments - one is conveniently divided in half, the other offers generous storage. All compartments have lockable zippers.
- Internal tie downs in large center compartment keep your gear secured.
- Radiused urethane wheels provide maneuverability and easy transport, even with the heaviest loads.
- Polymer "pull" handle with metal legs collapses completely into molded recess for travel.

Dimensions:

Center compartment is: 13 1/2" w x 27 1/2" h x 14" d

Top-end compartment is: 13 1/2" w x 13 1/2" h x 2" d

#100-UM-52451



Shooters Ridge Ultimate Range Bag

Complete kit for the shooter including bag, Front filled sand bag, eye and hearing protection, paper targets, and gun cleaning kit

- Bag - shooters ridge compact range bag made from durable 600 denier with pvc coating for rain and weather protection, built in padded, lockable pistol pouches, adjustable shoulder strap, double zippered main compartment for easy access, main compartment is 15" x 6 1/2" x 8"
- Front suede filled sand bag for steady aim
- Champion eyes and ears shooting glasses and 27 decibels noise rating hearing protection
- Champion traps and targets shotkeeper paper targets
- Outers universal gun cleaning kit - complete cleaning kit for .22 - .30 Caliber rifles, 9mm and .38 - .357 Caliber handguns and 12 gauge shotguns. Kit includes: 3 piece brass cleaning rod with handle, 4 phosphor bronze brushes, 2 spear pointed jags, 3 slotted patch tips, shotgun adapter, 25 micro-fiber patches, outers 2 oz tri-care clp (solvent and gun oil combination),
- Perfect for the new shooter or makes a great gift

#105-STR-40502



McNett Seam Grip

Seam Grip® Seam Sealer & Outdoor Repair is a waterproof flexible urethane formula for use in repairing surfaces or sealing seams of natural and synthetic fabrics, waterproof laminates, leather and vinyl. Available in 1 oz. Blister Pack and 8 oz.

#MCN-10510-SGS



Uncle Mike's Large Tactical Briefcase

Get the same versatility of our new small briefcase in a larger size. Stores all your range gear in an ultra-light, durable briefcase with plenty of room, a brand-new design and very little room for improvement.

- New design featuring multiple components.
- Constructed of lighter-weight, durable material.
- Includes foam molding for added protection

#100-UM-52582



Uncle Mike's Small Tactical Briefcase

This new briefcase features an improved design with plenty of pockets, pouches and compartments for a day at the range with everything that goes with it. Made with lighter-weight yet durable materials, this case is packed with versatility.

- New, improved design with more compartments.
- Constructed of lighter-weight material.
- Utilizes foam molding for added protection.

#100-UM-52581



Uncle Mike's Police Equipment Bags

- Carry bags with rigid bottom, front, back and end panels.
- Top is heavily padded.
- Handle collapses for storage and will fit in most police lockers.
- Lockable zippers.

Dimensions: Main compartment is 18 1/2" w x 12" h x 7 1/2" d

#100-UM-52471



Uncle Mike's Large Gear Bag

Our newly-designed bag provides plenty of room, lighter weight, and the extra protection of foam padding. Ideal for sports shooters and those in law enforcement, this new, versatile design has all the features needed for the range or the back of a squad car.

- Brand-new design.
- Constructed of lighter materials.
- Foam padding for added protection.

Dimensions: Center is 10" w x 20 1/2" l x 12" h

#100-UM-52590



M4 Carbine/Muzzelite Rifle Case

Cushioned zippered bag with Shoulder Straps and Modular MOLLE straps to attach utility bags. Fits the CAR-15 or rifles under 29" in length.

#SBI-MZ-CC



Go Bag/Large Utility Pouch

Modular MOLLE straps to attach on gun bag or vest with side and back mounts.

#SBI-90-CC



BACK OF POUCH TO SIDE OF BAG

Go Bag/Small Utility Pouch

Modular MOLLE straps to attach on gun bag or vest.

#SBI-SB-CC



M-Pro 7 Gun Cleaner

Vital to maintaining weapon reliability and performance by removing layers of fouling, embedded carbon, and conditioning the bore to help prevent future build-up.

- Significantly cuts cleaning time
 - Improves accuracy and reliability
 - Conditions to reduce future fouling
 - Removes carbon, lead and most copper fouling
- #100-MP7-071002 4oz Spray
#100-MP7-071015 2oz Spray



M-Pro 7 Copper Removal System

Copper fouling is trapped under layers of carbon. A systems approach is the only way to eliminate all copper.

- Up to 4x faster than ammonia based cleaners
 - Improves accuracy & reliability
 - Dissolves all copper fouling
 - Conditions to reduce future fouling
 - Safe on bore steel (for use inside the bore only)
 - Ammonia & odor free
- #100-MP7-071150 2oz Bottle
#100-MP7-071151 4oz Bottle



M-Pro 7 Cleaner Lubricant Protectant

Provides superior lubrication and corrosion protection. Use in conjunction with M-Pro 7 Gun Cleaner for deep cleaning and conditioning. M-Pro 7 Cleaner Lubricant Protectant's synthetic thin coat technology exceeds MIL-PRF-63460 and is rated at -55° to 800°+ Fahrenheit.

- Removes surface carbon quickly
- Repels dirt, dust and carbon
- Extreme climate protection
- Max temperature range lubrication (-85°F to 482°F)

#100-MP7-071403 4oz Bottle



Mil-Comm MC25 Cleaner/Degreaser 4 oz Pump Bottle

MC25® Firearm Cleaner Degreaser is Mil-Comm Products' environmentally safe, water based, pH balanced, non-toxic formula that emulsifies organic substances on contact including gun lubricants, powder residue and other debris. This non-toxic cleaner properly prepares all kinds of firearms for application of one of Mil-Comm Products' extreme performance lubricants. MC25® is proudly MADE IN THE U.S.A.

#MIL-MC25 4oz Spray



Mil-Comm TW25B grease .5 oz Reclosable Syringe

TW25B® Light Synthetic Grease is Mil-Comm Products' original formula and a top selling firearms lubricant worldwide. Its exceptional performance in adverse conditions has made it the choice of the U.S. Military and its Allies. TW25B grease is proudly MADE IN THE U.S.A. The plastic, tapered tip reclosable 0.5 oz. syringe is handy for applying a drop or bead to small or hard to reach areas. The tip head rotates to open or close flow.

#MIL-TW25B

Mil-Comm MC2500 oil .5 oz Reclosable Syringe

MC2500® oil is Mil-Comm Products' synthetic blend that is based on the same technology and delivers the same exceptional performance as TW25B® grease. The lower viscosity of MC2500® oil allows for easy migration to hard to reach weapon parts while its liquidity allows the user the ability to pour or pump the lubricant easily. These special characteristics of MC2500® oil make it outstanding for lubricating close-fitted, high-speed, extreme pressure precision parts. MC2500® is proudly MADE IN THE U.S.A.

#MIL-MC2500

Hoppe's Tornado Brushes

Known as "The Gunsmith's Brush", it has a special spiral-wound design that's highly effective at removing fouling, yet won't damage your rifling. Stainless steel loops eliminate any brittle ends that could leave scratches.

- #100-HP-1250 .22 caliber
- #100-HP-1251 .30 caliber
- #100-HP-1252 .35 caliber/9mm
- #100-HP-1254 .270 caliber
- #100-HP-1255 .32 caliber
- #100-HP-1256 .38 caliber
- #100-HP-1257 .44/.45 caliber
- #100-HP-1258 .40 caliber
- #100-HP-1260 12 gauge
- #100-HP-1261 16 gauge
- #100-HP-1262 20 gauge
- #100-HP-1263 .410 gauge



Hoppe's Cleaning Swabs

- 100% Cotton
 - Soft & Washable
 - Gentle, yet effective
- #100-HP-1317 .410 gauge
 - #100-HP-1317A 28 gauge
 - #100-HP-1318 20 gauge
 - #100-HP-1319 16 gauge
 - #100-HP-1320 12 gauge
 - #100-HP-1321 .22/.270 caliber
 - #100-HP-1322 .208/.32 caliber
 - #100-HP-1323 .35/.375 caliber
 - #100-HP-1324 .40/45 caliber
 - #100-HP-1325 17 MHR/.204



Hoppe's Phosphor Bronze Brushes

- Stout Bristles for effective cleaning
 - Soft & Washable
 - Gentle, yet effective
- #100-HP-1301P 6mm caliber
 - #100-HP-1302P .17 caliber
 - #100-HP-1303P .22 caliber
 - #100-HP-1304P .270 caliber/7mm
 - #100-HP-1305P .30 caliber
 - #100-HP-1306AP .32 caliber Pistol
 - #100-HP-1306P .22 caliber Pistol
 - #100-HP-1307AP 9mm Pistol
 - #100-HP-1307P .38 caliber Pistol
 - #100-HP-1308AP .40 caliber/10mm Pistol
 - #100-HP-1308P .44/.45 caliber Pistol
 - #100-HP-1309P .35 caliber/9mm
 - #100-HP-1310P .243/.25 caliber
 - #100-HP-1311P 410 gauge
 - #100-HP-1311AP 28 gauge
 - #100-HP-1312 20 gauge
 - #100-HP-1313 16 gauge
 - #100-HP-1314AP 10 gauge
 - #100-HP-1314P 12 gauge
 - #100-HP-1315P .44/.45 caliber
 - #100-HP-1316P .38 caliber



TAPCO AR15 Cleaning Stars

The AR15/M16 weapon requires clean chamber lugs to function properly. Attached to your standard bore brush, they quickly clean this often neglected area.

#STT-CLN0920 20 pack



Hoppe's Bore Light

Shed light on the condition of your bore. Illuminate the bore entirely to expose nicks, scratches, pits, and fouling.

- Great for safety checks and lighting hard-to-reach fouling.
 - Locking feature can keep light on for longer inspections
 - Indispensable for buyers of used firearms
 - Runs on two AA batteries (not included)
- # 100-HP-BRL1

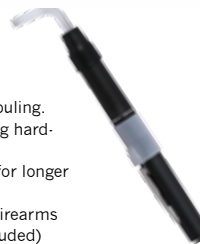

Gunslick Handgun Carbon Fiber Cleaning Rod

Stay straight and true when cleaning your handguns with Gunslick's new carbon fiber cleaning rod. At 8" in length, this carbon fiber rod is ideal for handgun cleaning and remains straight despite rigorous cleaning sessions. Soft, easy-grip handle makes this rod a pleasure to use while the ball-bearing rotation is gentle on your barrel yet tough on stubborn fouling

#105-GSP-35002



Gunslick 1-pc Carbon Fiber Cleaning Rods

All one-piece carbon fiber cleaning rod from Gunslick are extremely strong, straight and 36" in length. Carbon fiber offers the serious rifle shooter a rod that eliminates particle pickup and possible damage to your barrel. The soft grip handles add additional length and are ergonomically designed for comfort, as well as efficient cleaning. It contains ball bearings to ensure years of smooth rotation and function.

- #105-GSP-35004 Universal
- #105-GSP-32010 .17-.204 caliber
- #105-GSP-32011 .22-.260 caliber
- #105-GSP-32012 .270-.45 Cal Rifle/all Ga Shotgun

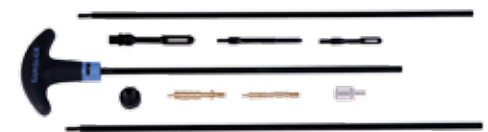

Gunslick Universal 3-Piece Coated Cleaning Rod

Protect your barrel and get a maximum clean with this new 3-piece sectional coated rod from Gunslick. Designed to be gentle on both the user and the firearm, this new rod uses an ergonomic T-handle and coated exterior to provide years of service of both shotguns and rifles. Perfect for carrying in your range bag or at home on your gun bench.

Kit Includes:

- 3 Piece Cleaning Rod
- Shotgun Slotted Tip
- .22 & .30 Caliber Brass Jags
- .22 & .30 Caliber Slotted Tips
- Muzzle Guard
- Shotgun Adaptor

#105-GSP-35010



MUZZLEMATE Cleaning Shield

Fast, easy and safe universal firearm cleaning tool - catch the mess! One size fits all, clamps to rifles, pistols and shotguns in seconds for complete protection.

The average firearm cleaning solvent is harmful or fatal if swallowed, requires medical attention if splattered into eyes or mouth, should not come in contact with skin and in some cases may even cause cancer and birth defects. Safe firearm cleaning should be a priority. You need the tools for safer, faster, easier maintenance. Hazardous chemical protection is important and MUZZLEMATE is the solution.

#MM-0316



Muzzlemate 3 Pack Replacement Tubes

#MM-0114



Hoppe's Shotgun Graphite Cleaning Rod
 No longer do professionals and serious sportsmen have to fear inadvertent metal contact that can harm fine rifling and affect accuracy. These Hoppe's one-piece graphite cleaning rods were created by Hoppe's to eliminate worries. Combining high strength and light weight, these rods are 100% graphite, not coated metal that can chip and peel. The advanced design has a comfortable, ergonomic handle too-the rifle rod even rotates to follow delicate barrel rifling. Length 36 inches.
#100-HP-RG1S

Hoppe's Elite Cleaning Rod System
 • Available in all rod diameters and lengths: pistol, rifle, shotgun and black powder.
 • Coated rods are high-quality spring steel.
 • Exceptional yield and tensile strength for years of service.
 • Coated rods employ a unique DuPont® hard epoxy coating for protection of rifling.
 • Accept standard 8-32 threaded brushes and jags.
 • Long enough to use with a Hoppe's Universal Bore Guide.
#100-HP-ER2230C .220 CAL 6.5MM 30"
#100-HP-ER2238C .220 CAL 6.5MM 38"
#100-HP-ER2244C .220 CAL 6.5MM 44"
#100-HP-ER2730C .270 CAL 30MM 30"
#100-HP-ER2738C .270 CAL 30MM 38"
#100-HP-ER2744C .270 CAL 30MM 44"

Hoppe's Soft Touch Cleaning Rod Handle
 Simply the most cost-effective way to own premium ball-bearing cleaning rods for all your firearms. A handle accepts all rod diameters and lengths.
 • Precision ball bearings for smooth rotation of rod.
 • Push-button rod attachment and detachment.
 • Accepts all rod diameters and lengths.
 • Padded, ergonomic design.
#100-HP-ECRH

Hoppe's Universal Bore Guide
 Keeps solvents from dripping into action and prevents excessive cleaning-rod contact with the rifling lands closest to the chamber.
 • Three interchangeable chamber tips to fit .17 to .416 caliber
 • Aluminum action collar fits .695"/.700" (17.65mm/17.78mm) diameter bolt actions of any action length
 • Threaded brass pin locks the guide into the action in place of the bolt to allow proper cleaning from the breech
#100-HP-UBG

Hoppe's Muzzle Guide
 Protect your muzzles from rod and cleaning handle contact. Simply fit against bore.
#100-HP-RMS Rifle
#100-HP-SMS Shotgun

Hoppe's Cleaning Cradle
 It sets up in seconds and securely holds any long gun in its over-molded rubber saddles.
 • Ideal for home, the range or on your tailgate in the field.
 • Adjusts for length.
 • Disassembles to fit in your range bag or cleaning kit.
#100-HP-HCC



Hoppe's Elite Soft-Sided BoreSnake Kit
 Strap this onto your belt or put it in your bag the next time you head out to the range or wilderness.
#100-HP-EBS12 12 gauge cleaning Kit
#100-HP-EBS9 9mm cleaning Kit



Hoppe's Bore Snake
 Hoppe's BoreSnake is the fastest bore cleaner on the planet. One pass loosens large particles, scrubs out the remaining residue with a bronze brush, then swabs it all spotless with a cleaning area 160X larger than a standard patch. Add a few drops of Hoppe's No. 9 Lubricating Oil or Hoppe's Elite and your gun's ready for storage.
 • The world's quickest, three-step bore shine.
 • Extremely packable.
 • Available for rifles, shotguns and pistols.

- #100-HP-24010** .17 cal. centerfire rifle
- #100-HP-24011** .22 cal. centerfire & rimfire rifle
- #100-HP-24012** 6mm, .243 caliber rifle
- #100-HP-24013** .25, 6.5mm, .264 caliber rifle
- #100-HP-24014** .270, 7mm, .284, .280 caliber
- #100-HP-24015** .308, 30-30, .30-06, .300, .303 caliber rifle
- #100-HP-24016** .32, 8mm caliber rifle
- #100-HP-24017** .338, .340 caliber rifle
- #100-HP-24018** .35, .350, .357, .358, .375 caliber
- #100-HP-24019** .416, .44, .45-70, .458, .460 caliber rifle
- #100-HP-24020** .50, .54 caliber rifle
- #100-HP-24025** .204 caliber rifle
- #100-HP-24026** .25 mm caliber rifle
- #100-HP-24000** .22 caliber handguns
- #100-HP-24001** .30, .32 caliber handguns
- #100-HP-24002** .380, 9mm, .38, .357 caliber handguns
- #100-HP-24003** .40, .41 caliber handguns
- #100-HP-24004** .44, .45 caliber handguns
- #100-HP-24031** 410 gauge shotguns
- #100-HP-24032** 28 gauge shotguns
- #100-HP-24033** 20 gauge shotguns
- #100-HP-24034** 16 gauge shotguns
- #100-HP-24035** 12 gauge shotguns
- #100-HP-24036** 10 gauge shotguns

Hoppe's 12" X 36" Cleaning Pad
 Attractive hunter green pad protects firearms and working surfaces from scratches and spills.
 • Soft acrylic material absorbs eight times its weight in fluids.
 • Non-slip vinyl backing keeps it in place and prevents soak-through.
 • Simply machine wash and air dry.
 • 12" x 36" for rifles and shotguns.
#100-HP-MAT2

Outers Silicone Gun And Reel Cloth 17X17
 Canton-flannel polishing cloth is impregnated with silicone, lubricants and corrosion inhibitors. Excellent for removing fingerprints.
#105-OTS-42028



Hoppe's Silicone and Reel Cloth
 • Take it anywhere for fast maintenance in the field.
 • Flannel cloth pre-treated with silicone lubricant.
 • Ideal for guns and fishing equipment.
 • Removes fingerprints and potentially corrosive epidermal oils.
 • Polishes and coats with a protective finish.
#100-HP-1218

Hoppe's Utility Brushes
 • Choose nylon or phosphor bronze bristles.
 • Two bristled ends - one for large area, the other for tight spots.
 • Intense strubbing without scratching
 • Extremely rugged design
 • Ideal for breeches & a myriad of other uses
#100-HP-1380 Nylon
#100-HP-1380P Phosphorus Bronze

Gunslick Cleaning Swabs
#105-GSP-91922 10 Pack



Gunslick Cleaning Picks
#105-GSP-91920 4 Pack

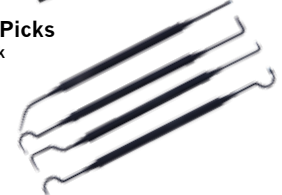

Gunslick Gun Cleaning Combo Pack
 • 4 Picks
 • 4 Swabs
 • 1 Double Ended Brush
#105-GSP-91924



Outers Synthetic Patches
 Absorbent patches help with removal of residue and excess chemicals, as well as apply lubricants and protectants. Available in cut-to-size specific caliber options.
#105-OTS-42317 1"x1" 225 CT for .17, 204, .225, .22 Cal
#105-OTS-42320 1.5"x1.5" 100 CT for .243-.270 Cal/.7MM
#105-OTS-42323 1.5" x 3" 50 CT for .30-.45Cal
#105-OTS-42326 100 CT for .22-.30 Cal
#105-OTS-42329 3"x 3" 25 CT for Shotguns

Outers Bulk Cleaning Patches
 Keep your barrels shiny clean with a bulk pack of patches from Outers.
#105-OTS-42382 .17-.22 cal - 7/8"x7/8" Cotton 250 CT
#105-OTS-42384 .23-.28 cal - 1 1/4" x 1 1/4" Cotton 250 CT
#105-OTS-42386 .30-.50 cal - 2" x 2" Cotton 225 CT

Pro Ears Gold Electronic Hearing Protection

The Gold Series Advantage is the balance achieved between comfort, noise attenuation and purity of sound. No compromises. No excuses.

Natural replication of amplified sound.

Real audiophiles understand that for purity of sound an analog sound system is superior to a digital sound system, however, digital systems can correct imperfections or enhance and modify sound better than analog systems. Most active hearing protectors or stereo headphones employ one technology or the other. Our engineers at Pro-Ears were not willing to compromise the quality of our sound for the sake of simplicity or cost. The result is the hybrid digital/analog system found exclusively in the Gold Series active hearing protectors.



Pro Ears Pro Tac Mag Gold

- Large ear cup designed for extreme noise environment. Maximum hearing protection
- Great for range masters and NRA shooting instructors
- Ideal for use with all handguns
- Scanner compatible for motor sports spectators
- Apple iPod, CD, motor sports scanner or radio compatible using a 3.5mm mini jack. Enjoy high fidelity sound while protecting your hearing
- Better than isolation headphones for blocking out unwanted noise while listening to music

#PE-GS-DPM-B Black · NRR 33
#PE-GS-DPM-G Green · NRR 33



Pro Ears Predator Gold

- Lowest profile cup for maximum concealment
- Light weight for extended hunting
- Contoured cup for turkey, duck and bird hunting
- Scanner compatible for motor sports spectators
- Cup size is suitable for the youth shooter
- Apple iPod, CD, motor sports scanner or radio compatible using a 3.5mm mini jack. Enjoy high fidelity sound while protecting your hearing

#PE-GS-P300-B Black · NRR 26



Pro Ears Pro Tac Slim Gold

- Medium profile cup is perfect for most firearms
- Excellent choice for the avid pistol shooter or IDPA or IPSC competitor
- For use on outdoor handgun ranges, comfortable all day wear
- For moderate to high noise environment; better noise reduction than most foam ear plugs
- Apple iPod, CD, motor sports scanner or radio compatible using a 3.5mm mini jack. Enjoy high fidelity sound while protecting your hearing

#PE-GS-DPS-B Black · NRR 28
#PE-GS-DPS-G Green · NRR 28



Pro Ears Sporting Clay Gold

- Worn by more Sporting Clay Champions than all other brands combined
- Chop-side cup with felt rifle protection improves sighting without scratching your stock
- Ideal for the trap or skeet shooter
- Apple iPod, CD, motor sports scanner or radio compatible using a 3.5mm mini jack. Enjoy high fidelity sound while protecting your hearing

#PE-GS-DSC-B Black · NRR 25



Pro Ears Passive Hearing Protection

The Ultra Series Advantage is the great comfort and noise attenuation with a Pro Ears Warranty

When situational awareness is not as essential to mission accomplishment. A great pair of passive ear muffs are the most effective means to protect your hearing. Ear plugs can be effective only if they are properly inserted in the ear. Very often, due to discomfort or improper training the ear plug does not provide the level of protection advertised. A comfortable, well designed pair of earmuffs can protect your hearing for years to come.

So comfortable you won't mind wearing these earmuffs all day. With ProForm leather ear cushions and soft flexible headbands the Ultra Series passive ear muffs are the most comfortable ear muffs on the market today.

Don't over protect, Too much protection can be unsafe as critical communication cues cannot be heard. Selecting the proper level of noise attenuation to protect your hearing while not over protecting is made easy with the three levels of protection offered by the Ultra Series.

Our reliability gives you the confidence to be your best. We believe in our passive earmuffs so much we have provided the longest, most comprehensive warranty in the industry. The NRR is independently tested and certified. All Ultra Series products are dielectric construction.

Pro Ears Ultra 28 Hearing Protection

- Medium profile cup
- Adjustable headband and ProForm leather ear cushions
- Hard hat adaptor, fits most hard hats (may not be suitable for wide-brim hard hats)
- Hard hat adaptor pivots and locks in the up position
- Dielectric construction
- Suitable for moderate to high noise environment; extended wear around noisy lawnmowers and chainsaws
- When noise level is high but you still need to be more aware of your environment
- 33% lighter than the Ultra 33

#PE-28-UB Black · NRR 28
#PE-28-UG Green · NRR 28
#PE-28-UC Camo · NRR 28
#PE-28-UP Pink · NRR 28
#PE-28-UPC Pink Camo · NRR 28



Pro Ears Ultra 26 Hearing Protection

- Thinnest, lightest cup for extended wear
- Adjustable headband and ProForm leather ear cushions
- Hard hat adaptor, fits most hard hats (may not be suitable for wide-brim hard hats)
- Hard hat adaptor pivots and locks in the up position
- Dielectric construction
- Suitable for low to moderate noise environments; wear while sand blasting or using a pressure washer

#PE-26-UB Black · NRR 26
#PE-26-UG Green · NRR 26
#PE-26-UC Camo · NRR 26
#PE-26-UNC Natural Camo · NRR 26
#PE-26-UP Pink · NRR 26
#PE-26-UPC Pink Camo · NRR 26



Pro Ears Ultra 33 Hearing Protection

- Rugged, high profile cups, Adjustable headband and ProForm™ leather ear cushions
- Hard hat adaptor, fits most hard hats (may not be suitable for wide-brim hard hats)
- Hard hat adaptor pivots and locks in the up position
- Dielectric construction
- Suitable for a high noise environment, both in the factory and in your home workshop

#PE-33-UB Black · NRR 33
#PE-33-UG Green · NRR 33
#PE-33-UC Camo · NRR 33
#PE-33-UP Pink · NRR 33
#PE-33-UPC Pink Camo · NRR 33



Don't let your shooting passion damage your hearing—rely on Champion protection when at the range or in the field.

Champion Ear Muffs

Enjoy safe shooting with new sound dampening ear muffs from Champion®. These comfortable, stylish muffs provide superior hearing protection while remaining light and comfortable for the shooter. Available in either standard or electronic versions, they reduce harmful noise levels and provide a comfortable fit for those long days of shooting.

Features & Benefits

- Available in both standard and electronic offerings
- Noise reduction for superior auditory protection
- Collapsible for easy storage
- Adjustable for best fit
- Electronic muffs to amplify quiet sounds and protect against harmful noise levels (NRR 21dB)

- #105-CHP-40970 Passive; 27dB NRR
- #105-CHP-40974 Electronic; 25dB NRR
- #105-CHP-40975 Pink Ear Muffs-Electronic; 25dB NRR



Passive; 27dB NRR

Electronic; 25dB NRR

Pink Ear Muffs-Electronic; 25dB NRR

Champion Gel Ear Plugs

Champion® promotes safe shooting with their new hearing protection plugs. Available individually on a soft nylon cord or in bulk pack, these soft silicone gel plugs feature a firm inner stem to insert comfortably into a shooter's ears for great auditory protection at an affordable price.

Features & Benefits

- Soft silicone gel for a comfortable fit
- Bulk pack available
- Individual ear plugs with cord for easy use
- The plugs have a noise reduction rating (NRR) of 26

- #105-CHP-40960 Ear Plugs - 4-pair, gel
- #105-CHP-40962 Ear Plugs - Corded w/ case, gel



Champion Molded Foam Plugs

Champion® promotes safe shooting with their new Molded Foam Plugs. Designed to contour to a shooter's ear, these soft foam plugs provide a comfortable fit that reduces the harmful noise levels commonly found at ranges.

Features & Benefits

- Soft tapered foam for maximum comfort
- Provides excellent hearing protection when shooting
- Lightweight and disposable

- #105-CHP-40958 Molded Foam Plugs-6 pair
- #105-CHP-40959 Molded Foam Plugs-100 pair



Champion Shooting Glasses

Champion® presents safe, stylish and practical shooting glasses for youth and adults. The frames come in a variety of colors and feature sharp, image-enhancing lenses available in clear, yellow, and smoke tint. Maximize your vision and protect your eyes next time you're at the range or in the field—slip on a pair of Champion Shooting Glasses. It's style and safety you can depend on.

Features & Benefits

- Exceptional comfort and wrap around safety
 - Sharp images with no distortion
 - OSHA compliant—maximum Z87.1 safety rated
 - Scratch resistant lenses
 - 99.9% UVA/UVB protection
 - Durable "fold smart" frames won't damage lenses
- #105-CHP-40606 Black Frame—Interchangeable Lens (Clear/Smoke/Yellow)
 - #105-CHP-40604 Black Curved Adjustable Frame—Yellow Tint Lens
 - #105-CHP-40605 Pink Curved Adjustable Frame—Pink Tint Lens

McNett Camo Form

Protective Camouflage Wrap. Flexible, self-cling wrap stretches to conform to any object, without affecting functional controls. Ideal for shotguns, rifles, bows, scopes, binoculars, flashlights, outboard motors, oars, dog collars & other gear. Reusable—allows for easy change of camouflage patterns. Quiets clanking gear, helps prevent scratches, reduces glare and protects form dirt and debris. Improves grip and insulates hands from cold surfaces. Weatherproof, adhesion is not affected by immersion in water. Prevents slippage of weapons on rocks, steep terrain and other smooth surfaces.

- #MCN-19411-USAD Army Digital
- #MCN-19414-BLK Black
- #MCN-19504-BRUSH Brush
- #MCN-19412-MDW Digital Woodland
- #MCN-19413-MDD Desert Mar Pat
- #MCN-19715-WDL Woodland Standard
- #MCN-19716-SNW Snow
- #MCN-19717-DST Desert Standard

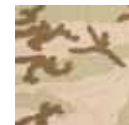

Desert Standard



Woodland Standard



Army Digital



Woodland Mar Pat



Desert Mar Pat



Snow

Bobbie Weiner 4 Color Woodland Camouflage Face Paint Kit

Camo preferred by the US Navy Seals. Now used by US Armed Forces worldwide. Four-color (Olive Green, Mud Brown, Grey, Black) kit comes with a unbreakable mirror, is waterproof, odorless and yet washes off with soap and water.

#CP-4000



Bobbie Weiner 5 Color Military Jumbo Camo Face Paint

Includes unbreakable mirror and is packed in a durable airtight, waterproof compact. Colors include: Black, White, Loam, Sand and Olive Green. Wedge sponge included in all 5 color Camo compacts.

#CP-4500



Bobbie Weiner Tri-Color Camouflage Face Paint Kit

Our original Camo. Find out why US troops were buying our Camo in PXs before it was made available by the Defense Department. Safe, Non-toxic, waterproof and washes off with soap and water. Ideal for hunters and outdoorsmen with a unbreakable mirror. The colors are Black, Olive, and Mustard.

#CP-1011



Bobbie Weiner ACU1 Tri Color Camouflage Face Paint Kit

Tan, Loam, and Slate Green. These new ACU Colors match the universal Camouflage patterns in all Govt new fabrics intended to blend into all environments. Unbreakable mirror included in compact.

#CP-ACU1



Bobbie Weiner 3-Color ACU Camo Face Paint Sticks

Tan, Black, and Olive Green. These new ACU Colors match the universal Camouflage patterns in all Govt new fabrics intended to blend into all environments.

#CP-ACU2



Bobbie Weiner 3-Color Camo Face Paint Sticks

Brown, Black, and Olive Green

#CP-T3000



CamoVat™ Cravat

More durable than current military issued cravats

- CamoVat Advantages
- Camouflage Pattern
- Water Repellent
- Anti Microbial
- Breathable
- Insulation Properties
- Lightweight Fabric
- Dust Filter
- Made in the USA

#MCN-5815-CVC



Ghillie Suit - Light Weight Synthetic Camouflage Ghillie

Complete jacket & pants weight - (medium = 5 lbs). We use a no-see-um fabric for the inside lining. This feels smooth to the skin so you can wear a t-shirt underneath. On the outside is a nylon netting. Attached to this netting is our synthetic string. The nylon netting allows you to add local vegetation to blend into your local surroundings.

The cuffs on the jacket and pants each have cord-locks sewn in to keep the bugs out. The jacket has a draw cord on the attached hood, and a draw cord at the waist. The jacket has a zipper, and there is a flap that covers the zipper. Velcro is sewn in to secure the flap, covering the zipper.

The pants have elastic sewn in the waist for added comfort, and most importantly, belt loops!

Sizes - each size runs a little larger, and longer.

	Part Number	Size	Waist Size
Mossy	#GHS-PP-NMS-MM	Medium	28" - 36"
	#GHS-PP-NMS-ML	Large	32" - 40"
	#GHS-PP-NMS-MXL	X-Large	36" - 50"
All Season	#GHS-PP-NMS-ASM	Medium	28" - 36"
	#GHS-PP-NMS-ASL	Large	32" - 40"
	#GHS-PP-NMS-ASXL	X-Large	36" - 50"





Ghillie Poncho - Full coverage - Head to toe!

This is a one piece camouflage ghillie poncho. It is a one-size-fits-all. It will fit a person up to 6'6" tall, and can be trimmed to fit your height. Has sleeves for your arms, and an attached hood. Has a 60" chest.

This is the most popular ghillie suit for those who want to wear it as is, or assemble it to bdu's, or other clothing. Jute thread hand tied with over 3000 knots to a 5' x 9' knotted nylon net. Netting has 1"x1" squares, and has 500 lbs. Of tensile strength. The jute thread has 10-12 lbs of tensile strength per strand. 4-5 Strands of jute thread are attached to every knot. Actual weight for the full poncho is 7.5 Lbs. Most popular!

- #GHS-P-M Mossy Color
- #GHS-P-W Woodland Color
- #GHS-P-D Desert Color
- #GHS-P-LG Leafy Green Color



Lightweight Camouflage Complete Ghillie Suit Kit!

- Kit includes the following
- One 5' x 9' nylon netting.
 - Seven colors of next generation synthetic thread. (3.5 Lbs. Total)
 - Complete directions on how to assemble kit into a lightweight camouflage ghillie poncho.
 - Synthetic thread colors include : brown, black, gray, light green, olive green, tan & dark green. Synthetic thread is the next generation in building a lightweight camouflage ghillie suit, because synthetic thread is:
 - Water-proof • rot-proof • mildew resistant • fire-retardant
 - washable • odor-less • non-allergenic
- #GHS-PP-GK-M Mossy Color
 - #GHS-PP-GK-W Woodland Color
 - #GHS-PP-GK-D Desert Color
 - #GHS-PP-GK-LG Leafy Green Color



Mossy Color



Woodland Color



Desert Color



Leafy Green Color

"Stalker" Ghillie Poncho

This is the suit for those of you who want to lay down to varmint hunt, or do a lot of crawling. Jute thread is hand tied to our nylon netting. Netting has 1"x1" squares, and a tensile strength of 500 lbs. The jute thread has 10-12 lbs of tensile strength per strand. 4-5 Strands of jute thread are attached to every knot. Has separate sleeves to put your arms through, and an attached hood. The front is open for those of you who like to crawl on your stomach, and can be easily converted to your favorite bdu's for a super sniper suit. Directions for the sniper suit can be found on our "how to build" section listed on the left. The inexpensive sniper suit!

Actual weight for the "stalker" is 6 lbs. One size fits all. May be trimmed to fit. The width of the rear piece that flows to the ground is 30" across! If you are a serious crawler. Take a look at our sniper suit built on to a pair of military BDU'S.

- #GHS-SP-M Mossy Color
- #GHS-SP-W Woodland Color
- #GHS-SP-D Desert Color
- #GHS-SP-LG Leafy Green Color
- #GHS-SP-WW Winter White



BDU Ghillie pants

Our same high quality jute thread is sewn directly on to military bdu trousers. These are made by "atlanco". The sewn on jute thread covers the back and the front. It is attached just below the pockets so the front pockets are accessible. (Weight 3.5 Lbs.)

- Sizes:**
- Small-Short Large-Regular
 - Small-Regular Large-Long
 - Small-Long Extra Large-Regular
 - Medium-Short Extra Large-Long
 - Medium-Regular 2X Large-Regular
 - Medium-Long 2X Large-Long
 - Large-Short
- #GHS-G-BDU-P-M Mossy Oak
 - #GHS-G-BDU-P-W Woodland Color
 - #GHS-G-BDU-P-D Desert Color
 - #GHS-G-BDU-P-LG Leafy Green Color



"Tracker" Ghillie Poncho

For those who only need the upper torso covered. This is the fast mobility suit. Designed for fast sprints, then kneeling down where you don't really need your lower half covered. The "tracker" has full sleeves for your arms, a generous hood, and covers the torso in front and back. Why buy a "rag" at other internet sites that don't cover the arms. Buy the "tracker"!

Assembled on a 100% nylon netting with 3.5 Lbs. of cut and dyed jute attached. Actual weight for the "tracker" is 4.5 Lbs." Add a pair of the sniper bdu pants to compliment this suit. Great for turkey hunters, or for those who will be kneeling down a lot.

- #GHS-TP-M Mossy Color
- #GHS-TP-W Woodland Color
- #GHS-TP-D Desert Color
- #GHS-TP-LG Leafy Green Color
- #GHS-TP-WW Winter White



BDU Ghillie Jacket

Our same high quality jute thread is sewn directly on to a military bdu 4 pocket coat. These are made by "atlanco". The sewn on jute thread covers the entire jacket in the front and the back, and has an attached hood. The hood is build the same way we build our ghillie poncho by hand tying the jute thread to a 1"x1" netting, and then sewing this to the jacket. This design allows you to stay cooler, allowing the wind to pass through, and also allows for better hearing. (Weight 6 lbs.)

- Size:**
- Small-Short
 - Small-Regular
 - Small-Long
 - Medium-Short
 - Medium-Regular
 - Medium-Long
 - Large-Short
 - Large-Regular
 - Large-Long
 - Extra Large-Regular
 - Extra Large-Long
 - 2X Large-Regular
 - 2X Large-Long
- #GHS-G-BDU-J-M Mossy Oak
 - #GHS-G-BDU-J-W Woodland Color
 - #GHS-G-BDU-J-D Desert Color
 - #GHS-G-BDU-J-LG Leafy Green Color



CRKT EDC Folding Knives

You should think about what you do everyday before selecting the knife. For example, if you work in a warehouse and cut up cardboard you should definitely consider a serrated blade. If you do alot of small detail work you should consider a small knife with a sharp tip. No matter what your day job is, CRKT has the right knife for you.



CRKT M16-01 EDC
Zytel Handle, AutoLAWKS, Razor-Sharp Edge
• Blade: Length: 3.00" (76 mm)
#110-CRKT-M16-01Z



CRKT M16-04 Zytel
Tanto, AutoLAWKS, Razor-Sharp Edge
• Blade: Length: 3.875" (98 mm)
#110-CRKT-M16-04Z



CRKT M16-12 Zytel
Combination Edge
• Blade: Length: 3.00" (76 mm)
#110-CRKT-M16-12Z



CRKT M21-02 Carson Folder G10
Razor Edge
• Blade: Length: 3.00" (76 mm)
#110-CRKT-M21-02G



CRKT Mini My Tighe
Assisted Opening, Black, Veff Combo Edge
• Blade: Length: 3.0" (76 mm)
#110-CRKT-1093K



CRKT M16-02 Zytel
Tanto, AutoLAWKS, Razor-Sharp Edge
• Blade: Length: 3.00" (76 mm)
#110-CRKT-M16-02Z



CRKT M16-10 EDC
Black - Zytel Handle, AutoLAWKS, Combo Edge
• Blade: Length: 3.00" (76 mm)
#110-CRKT-M16-10KZ



CRKT M16-12 E.R.
Tanto, Orange Zytel Handle, AutoLAWKS, Combo Edge
Combination Edge
• Blade: Length: 3.00" (76 mm)
#110-CRKT-M16-12ZER-O



CRKT M21-04 Carson Folder G10
Razor Edge
• Blade: Length: 3.875" (98 mm)
#110-CRKT-M21-04G



CRKT Lake Thunderbolt
Assisted Opening, Black, Veff Combo Edge
• Blade: Length: 3.90" (99 mm)
#110-CRKT-713Z



CRKT M16-03 Zytel
Spear Point, AutoLAWKS, Razor-Sharp Edge
• Blade: Length: 3.50" (89 mm)
#110-CRKT-M16-03Z



CRKT M21-12 Carson Folder G10
Combination Edge
• Blade: Length: 3.00" (76 mm)
#110-CRKT-M21-12G



CRKT M16-14 Zytel
Combination Edge
• Blade: Length: 3.875" (98 mm)
#110-CRKT-M16-14Z



CRKT M21-14 Carson

CRKT Tactical Knives

Folding tactical knives are easier to conceal and to carry everyday. Check out the folding Hissatsu that is an assisted opening knife and includes AutoLawks. James Williams can penetrate 1/2" plywood with this knife (don't try this at home!) Also, check out the M16 series designed by Kit Carson. This incredible line up of knives have been a staple for years for law enforcement and military personnel. The flipper offers quick, reliable deployment that will get you out of trouble in a hurry. Please take the time to look at what we have to offer in tactical folding knives. We think you will find one to fit your needs.



M16-13 Special Forces
Black G10 Handle, Tanto, AutoLAWKS, Veff Combo Edge
• Blade: Length: 3.50" (89 mm)
#110-CRKT-13SFGB



M16-14 Special Forces
Black G10 Handle, Tanto,

CRKT Fixed Blade Tactical Knives

At CRKT we offer a wide selection of fixed blade tactical knives. We work with designers like James Williams, Pat Crawford and several others to bring to you knives that work in tactical situations. For instance, model 2010, the dragon designed by Bob Kasper and Pat Crawford is a fixed blade with G10 handles for superior grip. It not only looks like a combat knife, it functions like one! The I.F.B. by Russ Kommer is a new fixed blade that is forged out of one peice of molton steel. If you break it, we will replace it!



Crawford N.E.C.K.
Sheath and MercHarness Included
• Blade: Length: 2.75" (70 mm)
#110-CRKT-2030CW



Crawford N.E.C.K.
Satin Finish, Sheath Included
• Blade: Length: 2.75" (70 mm)
#110-CRKT-2030

Case Saver

PRIMER POCKET SWAGE

Now you can re-swage worn primer pockets in your best match brass!

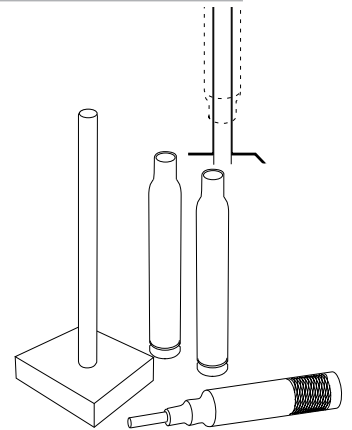
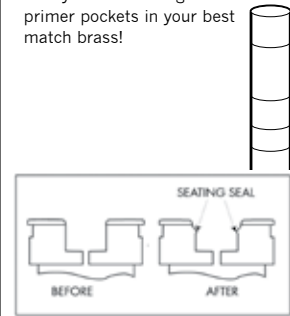

Large Punch & Anvil Set
#PPS-LG1-1PA

Small Punch & Anvil Set
#PPS-SM1-1PA

Large Punch Only
#PPS-LGP-000

Small Punch Only
#PPS-SMP-000

Large Anvil Only

Compression Tool

MSP Compression Tool makes short work of all those "Three Handed Jobs". Permits almost anything to be held in place while a spring is compressed.
#LLR-GS2-004



Three 6" lengths with 6 End Caps
#TUBE-06

Four 4" lengths with 8 End Caps
#TUBE-04



Plastic Tubes with End Caps

Cut your own sizes from:
2 - 18" lengths with 12 End Caps
#TUBE-18

Multi Compartment Plastic Box

8 1/4" x 4" x 1 1/4"
(12 Compartments)
#YLLR-PLBOX

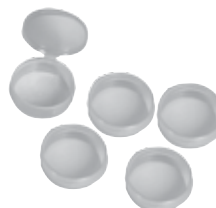

5 - Clear 1/4 oz. tube with snap-tight top
#YTUB

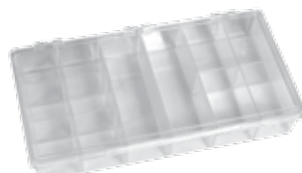

A

Accu-Shot 35
 Accu-Shot Atlas Bipod 37
 ACD 61
 Adams Arms 20
 Add-A-Rail System 8
 Advanced Tactical Camera 58
 Aimpoint 48–49
 AK Accessories 26
 Ameriglo
 Light Sticks 65
 Night Sights 43
 AR-15 Mounts & Accessories
 Carry Handle 9
 Charging Handle 20
 Grips 17
 Piston Conversion Kits 20
 Rail System 11–14
 Top Rail Riser 10
 Trigger Guard 17
 ArmaDynamics
 PMK Rifle Mount 25
 A.R.M.S.
 #1 28
 #17 9
 #18 29
 #22 7
 #35 7
 #36 10
 #38 10
 #40 19
 #41B 19
 #71L 19
 Carry Handle Mounts 9
 Flip Up Sight 19
 Rifle Sling 38
 Scope Rings 7
 S.I.R. SYSTEMS 11
 SPARTAN RAIL 11
 ATI
 10/22 Fiberforce Stock 22
 10/22 Strikeforce 22
 AK-47 Strikeforce 27
 Akita Adjustable Shotgun Stock 44
 AR-15 Forend Rails 14
 Forend Pistol Grip 34
 SKS 6 Position Side Folding Stock 25
 SKS Fiberforce Stock 25

B

Binoculars 62
 Bipods 37
 Browning Mounts 40
 BSA Scopes 58
 Buffer Technologies 33
 Bushnell
 Binocular 62
 Rifle Scope 59
 Butler Creek
 Flip-Open Scope Covers 57
 B&W International 70
 BYOB Build Your Own Rails 31

C

Camouflage 76–77
 Ghillie Suits 77
 Case Saver 78
 CDM Gear 46
 Champion
 Ear Muffs 75
 Shooting Glasses 75
 Targets 64
 Colt Mounts 40
 CRKT 78

D

Duostock 16

E

Elcan 51
 Eotech 50
 ERGO
 AK Grip 27
 AR-15 Grips 17

F93 AR-15 Stock 16
 FAL Grip 29
 HK Grips 28
 Three Rail Shotgun Forend 45
 Vertical Forward Grip 34

F

Fenix 67
 Flashlights 66–69
 FN FAL Accessories 29

G

Galil Accessories 28
 Galil Base 28
 GHOST 41
 Grip Pod 2
 Gun Cleaning 72–73
 Gunslick 72

H

Harris Bipods 36
 Hearing Protection 74–75
 H&K G3 Accessories 28
 Claw Mount 28
 MP5 Handguard Rail 28
 Holsters 70
 Hoppe's
 Bore Snake 73
 Brushes 72
 Horus Vision 56
 ASLI 56

I

IMS (Interchangeable Mounting Systems)
 9
 ITT Shot Shock 45
 IWC 15

K

Knives 78

L

Light Sticks 65
 L&M 28

M

M14/M1A Accessories 29
 Scope Mount 29
 Service Tools 29
 Magpul
 ACS Carbine Stock 15
 AFG 34
 ASAP Ambidextrous Sling
 Attachment Point 38
 CTR Stocks 16
 HK PRS-G3 28
 MBUS Sights 19
 MIAD Grip 17
 MOE Grip 17
 MOE Hand Guard 15
 MS2 Multi Mission Sling System 38
 PRS Stock 16
 Rail Panels 14
 RVG Rail Vertical Grip 34
 UBR Stock 15
 McNETT
 Camo Form 76
 Micro Fiber Towel 63
 OpDrops Anti-Fog & Lens Cleaning 63
 MFI 28
 Millett 59
 Milling Block 31
 Mini 14/30 Accessories 24
 Mount 24
 Recoil Buffer 24
 Stocks 24
 MOA Solutions 8
 Monopods 35
 M-Pro 72
 MUZZLEMATE 72

N

NcStar
 AK-47 Tri-Rail 27
 NcStar Scope Rings 4
 Red Dot Sight 60
 Rifle Scopes 60
 NEBO 68
 Nightforce Optics 56
 Angle Degree Indicator 61
 Night Vision Mounts 18
 PVS-14 Mounts 18
 PVS-17 Mount 18
 PVS-18 18
 Raptor Mount 18

P

PMK Rifle Mount 25
 PRI
 Accuracy Conversion Base 32
 Carbon Fiber Upper 13
 Flip Sight 19
 PRI Scope Rings 6
 Remington 700 MOA Bases 30
 Pro Ears 74

R

Redfield
 Redfield Scope Rings 4
 Remington 700 Accessories 30
 Mounts 30
 Trigger 33
 RIANOV 61
 Rifle Basix Triggers 33
 Rifle Cases 70
 Rifle Scopes 48–61
 Flip-Open Scope Covers 57
 Rifle Slings 38
 Ruger 10/22 Accessories 22–23
 10/22 Mounts & Bases 23
 Stocks 22
 Ruger Mounts 40

S

Sadlak Industries 29
 Saiga Accessories 27
 Samson MFG
 AK-47 Rear Sight Rail 27
 Flip Up Sight 19
 K-Rail 27
 Savage Mounts 31
 Scope Rings 4–7
 Shooters Ridge
 Bi-Pods 37
 Shotgun Accessories 44
 Shotgun Forends 45
 Shotgun Mount 46
 Shotgun Recoil Buffer 45
 Shotgun Stocks 44
 Sights 47
 Sig 542 Base 32
 Sightlink 18
 SKS Accessories 25
 Mounts & Bases 25
 Stocks 25
 Smith & Wesson Mounts 41
 S.P.O.T. Red Dot Scope 51
 Spotting Scopes 63
 Streamlight 68
 SureFire 66

T

TAPCO
 AR-15 Collapsible Stock 17
 FAL Stock 29
 Intrafuse 10/22 22
 Intrafuse AR Handguard 17
 Intrafuse Shotgun T6 Stock 44
 Intrafuse SKS 25
 Intrafuse Vertical Grip 34
 Rifle Sling System 38
 Targets 64
 Trijicon 52
 AccuPoint 53

ACOG 52
 Night Sights 54
 RMR 54
 TriPowe 54
 Tri-Link 47

U

Uncle Mike's
 Bag 71
 Holsters 70

V

Vortex Optics 55, 62
 SPARC 55

W

Weaver
 AR-15 grips 16
 Scopes 57
 Tactical Two Piece Rail Forend 14
 Vertical Grips 34
 Weaver Scope Rings 5
 Weaver Steel Top Mount Bases 32
 Weigand Combat 40

X

Xenonics SuperVision - 58

Mounting Solutions Plus
10655 S.W. 185 Terrace
Miami, FL 33157

1-800-428-9394
Fax: (305) 232-1247
www.mountsplus.com



A Proud Distributor Of



Mounting Solutions Plus
10655 S.W. 185 Terrace
Miami, FL 33157

1-800-428-9394
Fax: (305) 232-1247
www.mountsplus.com